

# ATHENA AT. PR

INSTRUCTIONS MANUAL

EN

HANDBUCH

DE

MANUAL DE INSTALACION

ES

MANUEL D'INSTALLATION

FR









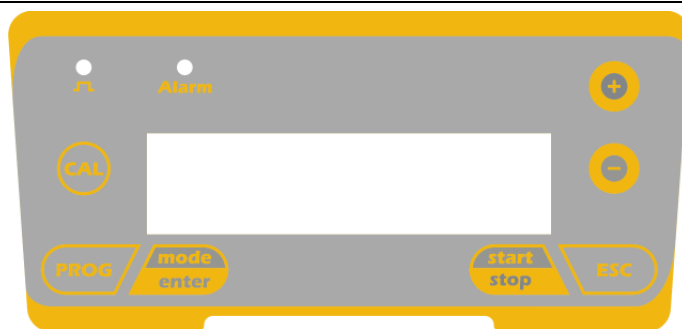

MANUALE D'INSTALLAZIONE

IT



## ATHENA AT. PR Control Panel



	Access to the programming menu
	When pressed during the pump operation phase, it cyclically displays the programmed values on the display; When pressed at the same time as the   keys, it increases or lowers a value dependent on the selected operating mode. During programming it carries out an “enter” function, meaning that it confirms entry to the various menu levels and modifications within the same.
	Starts and stops the pump. In the event of a level alarm (alarm function only), flow alarm and active memory alarm, it deactivates the signal on the display.
	Used to “exit” the various menu levels. Before definitively exiting the programming phase, you will be asked if you wish to save any changes.
	Access to the pump calibration menu. If in Off mode, the calibration menu is not activated.
	Used to run upwards through the menu or increase the numerical values to be changed. Can be used to start dosage in Batch mode
	Used to run downwards through the menu, or decrease the numerical values to be changed.
	Flashing green LED during dosage
	Red LED that lights up in various alarm situations

### Electrical connections

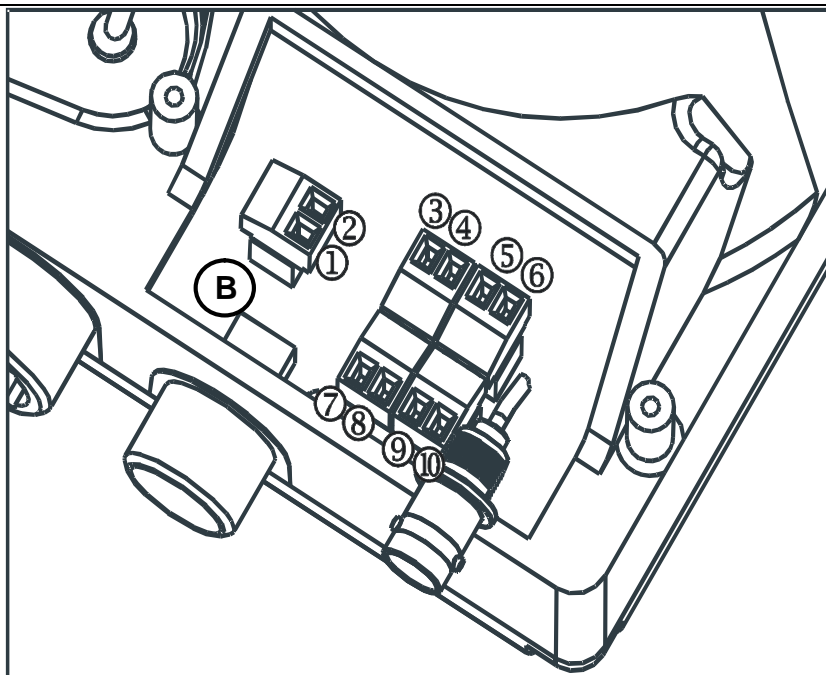
	1	Alarm relay	
	2		
	3	Pole +	4-20 mA Output
	4	Pole -	
	5	Remote control input (start-stop)	
	6		
	7	Temperature probe input	
	8		
	9	Flow sensor input	
	10		
B	Input level control		

# Athena AT. PR Programming Menu

You can access the programming menu by pressing the **PROG** key for over three seconds. The **+** **-** keys can be used to run through the menu items, with the **mode enter** key being used to access changes. The pump is programmed in constant mode in the factory. The pump automatically returns to the operating mode after 1 minute of no activity. Any data entered in these circumstances will not be saved. The **ESC** key can be used to exit the various programming levels. Upon exiting programming, the display will show:

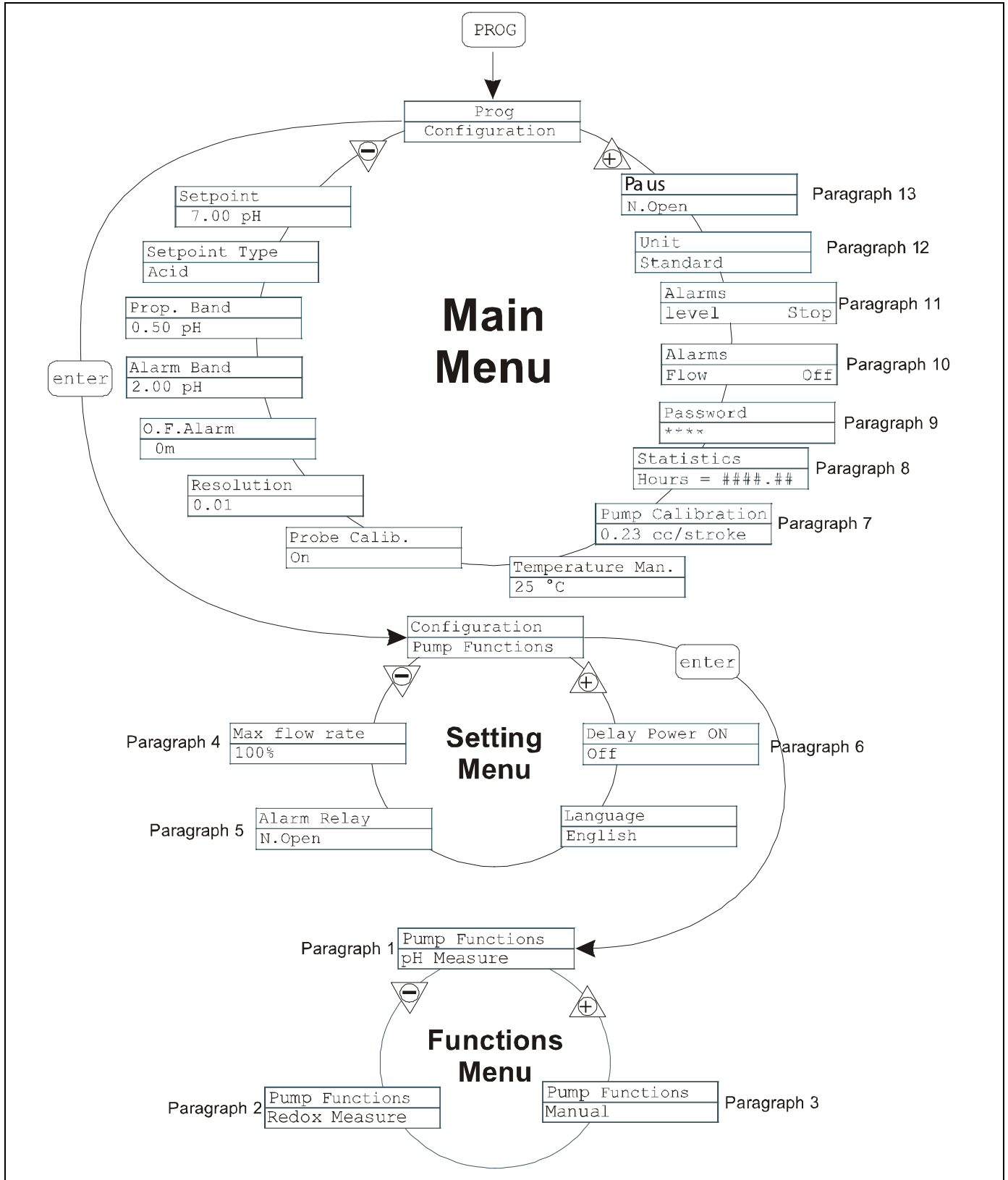
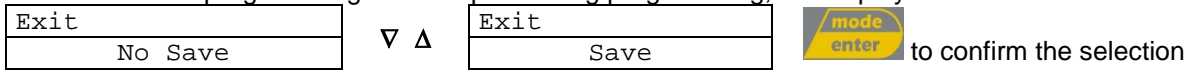

## Setting the Language

Programming	Operation
	<p>Makes it possible to select the language. The pump is set in English in the factory.</p> <p>Changes can be made by pressing the  key, then using the   keys to set the new value. Press  to confirm and return to the main menu</p>

## Paragraph 1 – Dosage Proportional to the pH value

Programming	Operation
	<p>The pump measures and controls the pH of a solution, programming in sequence: set-point, set-point type, proportional band and alarm band</p> <p>Set-point type: acid</p> <p>Set-point type: alkaline</p> <p>It is also possible to programme:</p> <ul style="list-style-type: none"> <li>- the O.F.A. (Over Feed Alarm) time in minutes, or rather a time beyond which an alarm signal is triggered if the pH value does not reach the set-point.</li> <li>- The measurement resolution (1 or 2 decimal points)</li> <li>- Deactivation/activation of the calibration procedure</li> <li>- Manual temperature value in °C (default) or °F</li> </ul> <p>The maximum frequency can be modified during operation, by pressing the  keys at the same time to increase the flow, or the  keys to decrease it.</p>

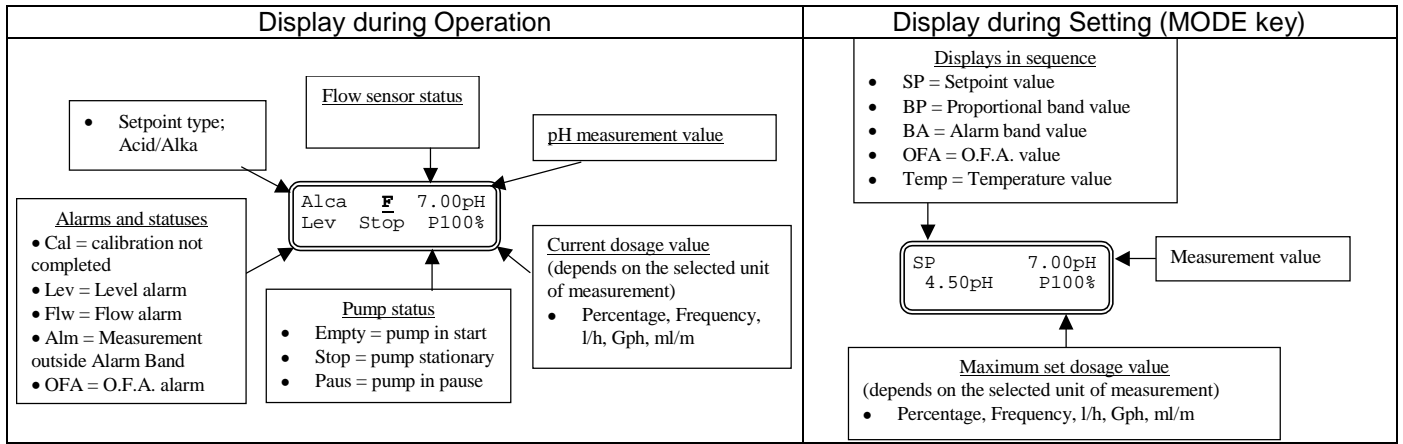

Paragraph 2 – Dosage Proportional to the Potential Redox Measurement (O.R.P.)

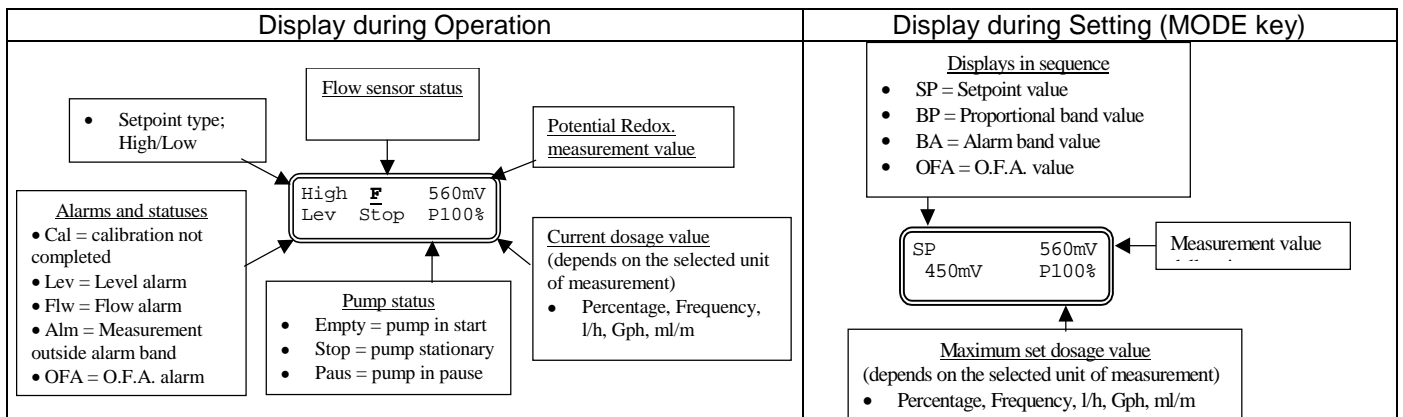
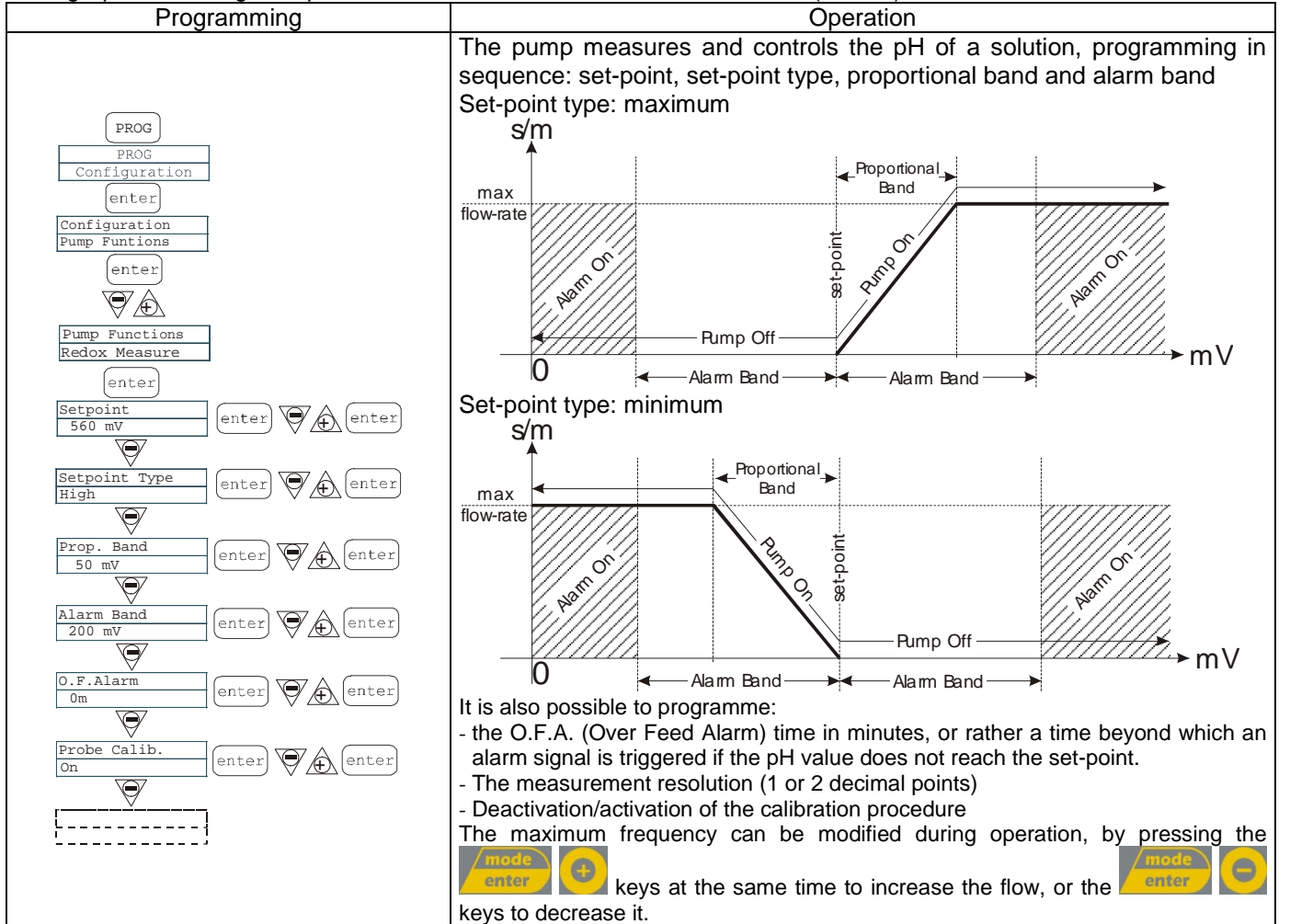

Paragraph 3 – Manual Dosage

Programming	Operation
<pre> graph TD     A[PROG] --&gt; B[PROG Configuration]     B --&gt; C[enter]     C --&gt; D[Configuration Pump Functions]     D --&gt; E[enter]     E --&gt; F[Navigation]     F --&gt; G[Pump Functions Manual]     G --&gt; H[enter]     H --&gt; I[ ]                     </pre>	<p>The pump operates in constant mode. The flow can be manually regulated by pressing the  keys at the same time to increase the flow, or the  keys to decrease it.</p>

Display during Operation	Display during Setting (MODE key)
<p><b>Operating mode</b></p> <ul style="list-style-type: none"> <li>Man = Manual</li> </ul> <p><b>Alarms and statuses</b></p> <ul style="list-style-type: none"> <li>Liv = Level alarm</li> <li>Fls = Flow alarm</li> </ul> <p><b>FLOW sensor status</b></p> <p><b>Current dosage value (depends on the selected unit of measurement)</b></p> <ul style="list-style-type: none"> <li>Percentage, Frequency, l/h, Gph, ml/m</li> </ul> <p><b>Pump status</b></p> <ul style="list-style-type: none"> <li>Empty = pump in start</li> <li>Stop = pump stationary</li> <li>Paus = pump in pause</li> </ul>	<p><b>Display during Setting (MODE key)</b></p> <p><b>Operating mode</b></p> <ul style="list-style-type: none"> <li>Displays the corresponding frequency value</li> </ul> <p><b>Current dosage value</b></p> <ul style="list-style-type: none"> <li>The maximum flow can be modified by pressing the + or – keys at the same time</li> </ul>

Paragraph 4 – Setting the Maximum Flow

Programming	Operation
<pre> graph TD     A[PROG] --&gt; B[PROG Configuration]     B --&gt; C[enter]     C --&gt; D[Configuration Pump Functions]     D --&gt; E[Navigation]     E --&gt; F[Max flow rate P100%]     F --&gt; G[enter]     G --&gt; H[Max flow rate P100%]     H --&gt; I[Navigation]     I --&gt; J[Max flow rate F320s/m]     J --&gt; K[enter]     K --&gt; L[Navigation]     L --&gt; M[ ]                     </pre>	<p>This makes it possible to set the maximum flow offered by the pump, and the programmed mode (% or frequency) is used as the standard unit of measurement when displaying the flow. Changes can be made by pressing the  key, then using the   keys to set the new value. Press  to confirm and return to the main menu</p>

Paragraph 5 – Setting the Alarm Relay

Programming	Operation
<pre> graph TD     A[PROG] --&gt; B[PROG Configuration]     B --&gt; C[enter]     C --&gt; D[Configuration Pump Functions]     D --&gt; E[Navigation]     E --&gt; F[Max flow rate P100%]     F --&gt; G[Navigation]     G --&gt; H[Alarm Relay N.Open]     H --&gt; I[enter]     I --&gt; J[Alarm Relay N.Open]     J --&gt; K[Navigation]     K --&gt; L[ ]                     </pre>	<p>This is used to set the alarm relay in the absence of an alarm situation, if open (default) or closed.</p> <p>Changes can be made by pressing the  key, then using the   keys to set the new value. Press  to confirm and return to the main menu</p>

Paragraph 6 – Power On Delay Setting

Programming	Operation
	<p>Allows the user to set a pump activation delay time when turning on the pump itself. This delay will only take effect if the pump is turned off and then on again by disconnecting its electrical power supply. The setting can be disabled (Off - factory default) or else can be set to a delay time ranging from 1 to 60 minutes.</p> <p>The alarm and pulse LED indicators will flash while the delay time is in progress (1 sec ON - 1 sec Off) and the countdown will be shown on the display in seconds. If the pump is in Stop mode, the LEDs alone will be flashing. While the time delay is in progress, the function can be disabled by accessing the menu and setting the time to Off.</p> <p>Press  to access the modification option and use the  and  buttons to set the desired value. Press  to confirm and return to the main menu.</p>

Paragraph 7 – Flow Calibration

Programming	Operation
	<p>The memorised cc value per strike appears in the main menu. It can be calibrated in two different ways:</p> <p><b>MANUAL</b> – manually enter the cc value per strike using the   keys and confirm by pressing the  key</p> <p><b>AUTOMATIC</b> – the pump makes 100 strikes, which are started by pressing the  key. At the end of this process, enter the quantity sucked up by the pump using the   keys and confirm by pressing the  key. The entered figure will be used in flow calculations.</p>

Paragraph 8 - Statistics

Programming	Operation
	<p>The main menu displays the pump operation times. By pressing the  key you can access other statistics:</p> <ul style="list-style-type: none"> <li>- Strokes = number of strokes made by the pump</li> <li>- Q.ty (L) = quantity dosed by the pump in litres; this figure is calculated on the basis of the memorised cc/stroke value</li> <li>- Power = number of pump starts</li> <li>- Reset = use the   to reset the counters (YES) or otherwise (NO), then confirm by pressing the  key.</li> </ul> <p>Pressing the  key will take you back to the main menu.</p>



Paragraph 9 - Password

Programming	Operation
<p>The flowchart shows the navigation from the main menu to the password configuration screen. It starts with 'PROG', then 'PROG Configuration'. A dashed line indicates a menu separator. Below it, 'Password ****' is shown. Pressing 'enter' leads to 'Password 0000'. From here, pressing '+', '-', 'mode enter', or 'enter' leads to a dashed box representing the next screen.</p>	<p>By entering the password, you can enter the programming menu and see all the set values. The password will be requested whenever you seek to modify them. The flashing line indicates the number that can be modified.</p> <p>Use the  key to select the number (from 1 to 9), and the  key to select the number to be modified. Confirm by pressing the  key. By setting "0000" (default), the password is eliminated.</p>

Paragraph 10 – Flow Alarm

Programming	Operation
<p>The flowchart shows the navigation to the flow alarm settings. It starts with 'PROG', then 'PROG Configuration'. A dashed line indicates a menu separator. Below it, 'Alarms Flow Off' is shown. Pressing 'enter' leads to 'Alarm Flow Off'. Pressing '+/-' leads to 'Alarm Flow On'. Pressing '+/-' leads to 'Alarm Flow - On Signals 6'. Pressing '+/-', 'mode enter', or 'enter' leads to 'Alarms Flow Off'. Pressing 'ESC' leads to a dashed box representing the next screen.</p>	<p>This makes it possible to activate (deactivate) the flow sensor.</p> <p>When activated (On), press the  key to access the request for the number of signals that the pump waits for before an alarm is triggered. The number flashes when you press the  key, and you can then use the   keys to set the value. Confirm by pressing the  key.</p> <p>Press  to return to the main menu</p>

Paragraph 11 – Level Alarm

Programming	Operation
<p>The flowchart shows the navigation to the level alarm settings. It starts with 'PROG', then 'PROG Configuration'. A dashed line indicates a menu separator. Below it, 'Alarms Level Stop' is shown. Pressing 'enter' leads to 'Alarm Level Stop'. Pressing '+/-' leads to 'Alarm Flow Alarm'. Pressing '+/-', 'mode enter', or 'ESC' leads to 'Alarms Level Alarm'. Pressing 'mode enter' leads to a dashed box representing the next screen.</p>	<p>This makes it possible to set the pump when the level sensor alarm is activated. In other words you can decide whether to stop dosage (Stop) or simply activate the alarm signal without stopping dosage.</p> <p>Changes can be made by pressing the  key, then using the   keys to set the alarm type. Confirm by pressing the  key. Press  to return to the main menu</p>

Paragraph 12 – Flow Display Unit

Programming	Operation
<p>The flowchart shows the navigation to the flow display unit settings. It starts with 'PROG', then 'PROG Configuration'. A dashed line indicates a menu separator. Below it, 'Unit Standard' is shown. Pressing 'enter' leads to 'Unit Standard &lt;-'. Pressing '+/-' leads to 'Unit L/h'. Pressing 'enter' leads to a dashed box representing the next screen.</p>	<p>This makes it possible to set the dosage unit of measurement on the display.</p> <p>Changes can be made by pressing the  key, then using the   keys to set the unit of measurement, choosing between L/h (litres/hour), Gph (Gallons/hour), ml/m (millilitres/minute) or standard (% or frequency, depending on settings). Press  to confirm and return to the main menu</p>

Paragraph 13 - Setting the Pause

Programming	Operation
	<p>The pump can be paused by remote input. The factory setting is Normally Open.</p> <p>Changes can be made by pressing the  key, then using the   keys to set the new value ( N. OPEN or N. CLOSED).</p> <p>Press  to confirm and return to the main menu.</p>

**pH Calibration Menu**

Pressing the CAL key for 3 seconds takes you into the calibration menu. If calibration was excluded during programming, the following appears on the display:

Calibration
Off

If calibration is active:

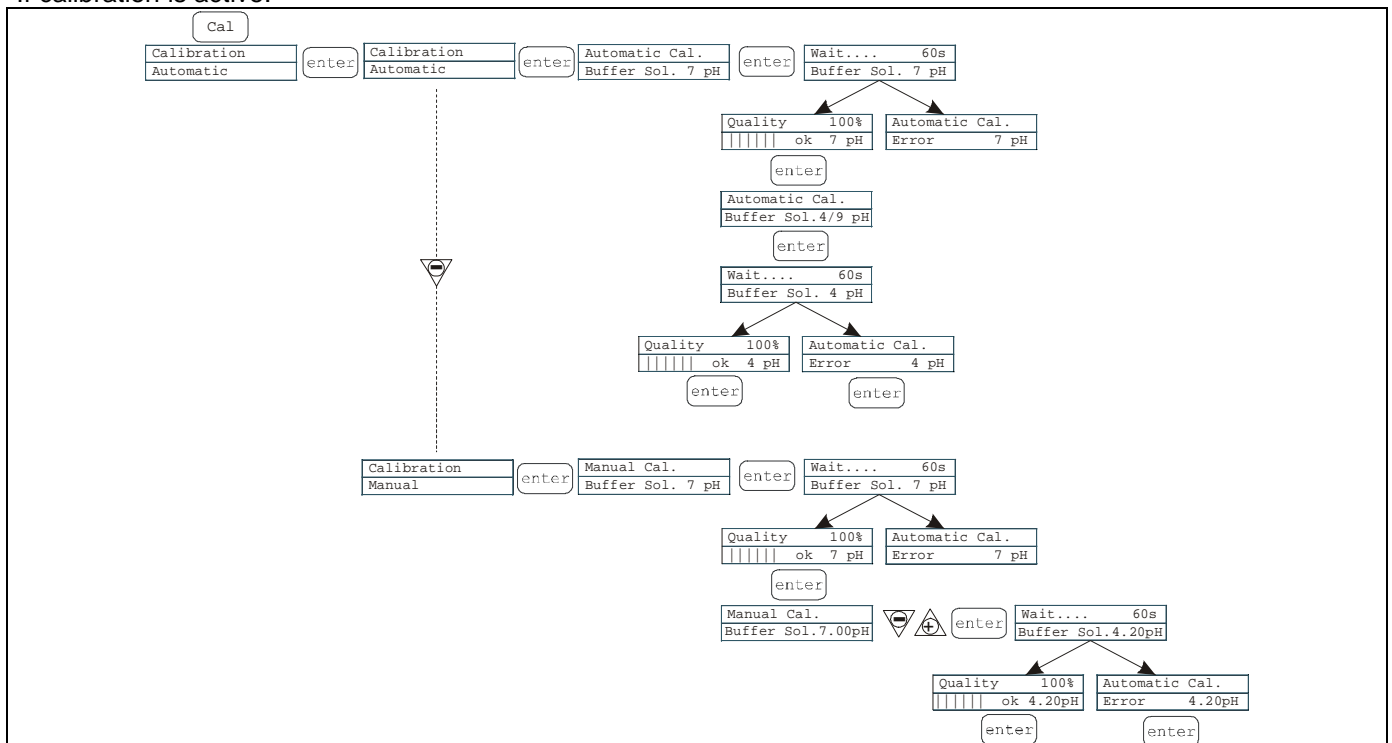

It is possible to select automatic or manual mode. In both cases, it is automatically calibrated to pH 7.

- Automatic calibration:

The buffer solution value appears on the display. Enter the probe in the bottle and press the key. A 60 second countdown necessary to complete calibration will appear on the display. If the alignment quality is below 50%, an error message appears on the display and you should press to exit calibration (the pump exits automatically after 4 seconds). If the quality is above 50%, the value is shown on the display and, after pressing the key, the buffer solution at pH 4 or 9 will be requested. At this point the procedure is the same as above.

- Manual calibration:

when the buffer solution value appears on the display, insert the probe in the bottle and press the key. A 60 second countdown necessary to complete calibration will appear on the display. If the alignment quality is below 50%, an error message appears on the display and you should press to exit calibration (the pump exits automatically after 4 seconds). If the quality is above 50%, the value is shown on the display and, after pressing the key, the value of pH 7.00 flashes on the display. Use the keys to enter the value of the solution in your possession, then press to confirm and start the calibration procedure as before.

**Potential Redox Calibration Menu (O.R.P.)**

Pressing the CAL key for 3 seconds takes you into the calibration menu. If calibration was excluded during programming, the following appears on the display:

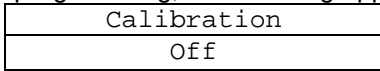

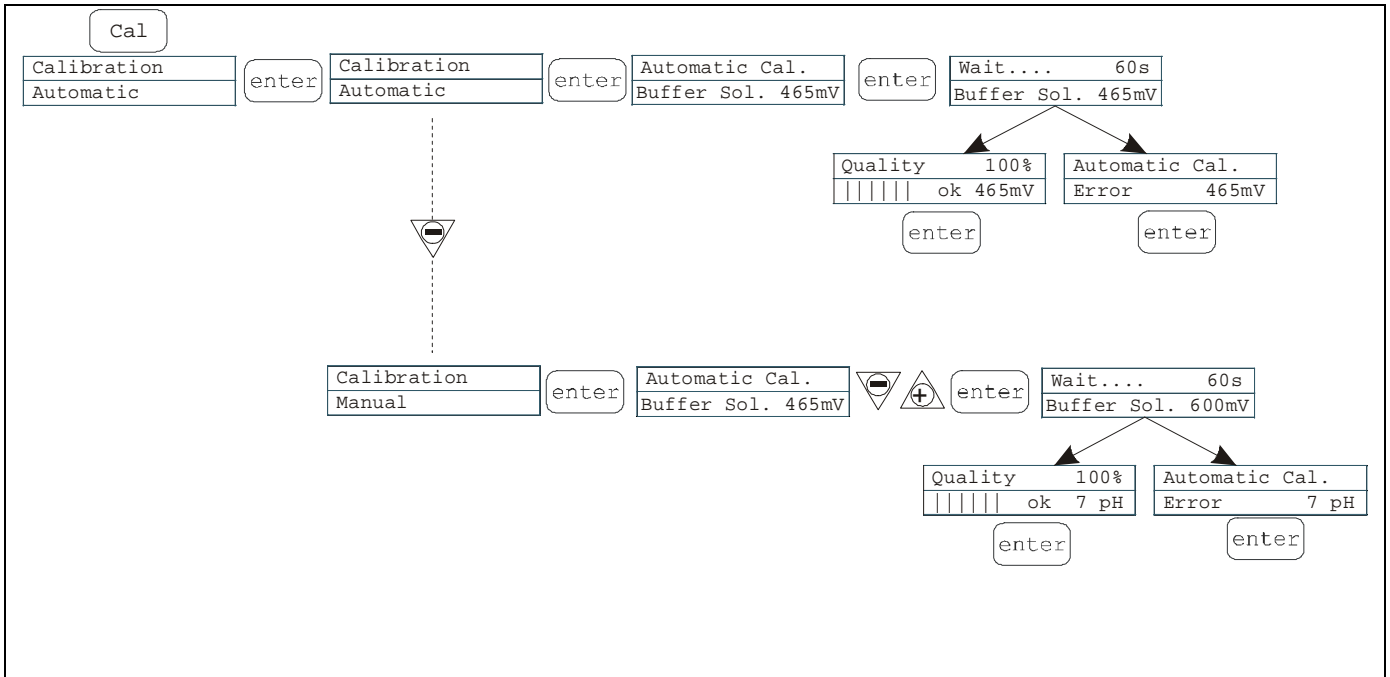

If calibration is active:







It is possible to select automatic or manual mode.



- Automatic calibration:

The buffer solution value appears on the display. Insert the probe in the bottle and press the  key. A 60 second countdown necessary to complete calibration will appear on the display. If the alignment quality is below 50%, an error message appears on the display and you should press  to exit calibration (the pump exits automatically after 4 seconds). If the quality is above 50%, the value is shown on the display and you should press the  key to complete the procedure.

- Manual calibration:

The buffer solution value appears on the display. Insert the probe in the bottle and press the  key. The value of 465 mV should now flash on the display. Insert the probe in your solution and use the   keys to display the value of the solution in your possession, then confirm by pressing the  key and begin the calibration procedure as before

## Alarms

Display	Cause	Interruption				
Fixed alarm LED Flashing word "Lev" I.e. <table border="1" style="display: inline-table; vertical-align: middle;"><tr><td>Man</td><td></td></tr><tr><td>Lev</td><td>P100%</td></tr></table>	Man		Lev	P100%	End of level alarm, without interrupting pump operation	Restore the liquid level.
Man						
Lev	P100%					
Fixed alarm LED Flashing words "Lev" and "stop" I.e. <table border="1" style="display: inline-table; vertical-align: middle;"><tr><td>Man</td><td></td></tr><tr><td>Lev Stop</td><td>P100%</td></tr></table>	Man		Lev Stop	P100%	End of level alarm, with interruption to pump operation	Restore the liquid level.
Man						
Lev Stop	P100%					
Fixed alarm LED Flashing word "Flw" I.e. <table border="1" style="display: inline-table; vertical-align: middle;"><tr><td>Man</td><td><b>E</b></td></tr><tr><td>Flw</td><td>P100%</td></tr></table>	Man	<b>E</b>	Flw	P100%	Active flow alarm. The pump has not received the programmed number of signals from the flow sensor.	Press the  key
Man	<b>E</b>					
Flw	P100%					
I.e. <table border="1" style="display: inline-table; vertical-align: middle;"><tr><td>Parameter Error</td><td>PROG</td></tr><tr><td>to default</td><td></td></tr></table>	Parameter Error	PROG	to default		Communication error with the eeprom.	Press the  key to restore the default parameters.
Parameter Error	PROG					
to default						
Flashing word "OFA" Flashing word "stop" I.e. <table border="1" style="display: inline-table; vertical-align: middle;"><tr><td>High</td><td>475 mV OFA</td></tr><tr><td>Stop</td><td>P 75%</td></tr></table>	High	475 mV OFA	Stop	P 75%	O.F.A. alarm	Press the  key to stop the flashing word "stop". Press the key again to start up the pump again.
High	475 mV OFA					
Stop	P 75%					
Flashing word "Alm" I.e. <table border="1" style="display: inline-table; vertical-align: middle;"><tr><td>High</td><td>475 mV Alm</td></tr><tr><td>P</td><td>75%</td></tr></table>	High	475 mV Alm	P	75%	The probe reading is outside the set alarm band range	Make sure that the "Alarm Band" parameter is set correctly in the programme
High	475 mV Alm					
P	75%					
Flashing word "Cal" I.e. <table border="1" style="display: inline-table; vertical-align: middle;"><tr><td>High</td><td>475 mV Cal</td></tr><tr><td>P</td><td>75%</td></tr></table>	High	475 mV Cal	P	75%	Probe not calibrated alarm	Calibrate the probe
High	475 mV Cal					
P	75%					

## ATHENA AT. PR

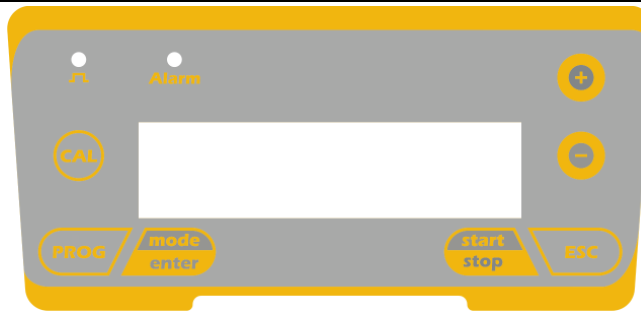





	Zugriff auf das Programmiermenü
	Während des Pumpenbetriebs: Durch Drücken werden die programmierten Werte zyklisch auf dem Display angezeigt; bei gleichzeitigem Drücken der Tasten   wird ein Wert, je nach ausgewähltem Betriebsmodus, erhöht bzw. verringert. Während der Programmierung übernimmt diese Taste die Funktion "Enter", d.h. dass der Zugriff auf die verschiedenen Menüstufen und die dort vorgenommenen Veränderungen bestätigt werden.
	Startet und stoppt die Pumpe. Wenn ein Füllstandsalarm (nur Alarmfunktion), ein Durchflussalarm und ein Memoryalarm aktiv ist, deaktiviert diese Taste die Anzeige auf dem Display.
	Zum "Verlassen" der verschiedenen Menüstufen. Vor dem endgültigen Verlassen der Programmierung, öffnet sich ein Speicherungsdialog für Veränderungen.
	Zugriff auf das Kalibrierungsmenü der Pumpe. Im Off-Modus wird das Kalibrierungsmenü nicht aktiviert.
	Blättert nach oben im Menü, oder erhöht die numerischen Werte, die verändert werden sollen. Im Batch-Modus kann diese Taste die Dosierung starten.
	Blättert nach unten im Menü, oder verringert die numerischen Werte, die verändert werden sollen.
	Grüne Led, die während dem Dosiervorgang blinkt.
	Rote Led, die sich bei den verschiedenen Alarmsituationen einschaltet.

### Anschlüsse Elektrik

	1	Alarmausgang ( Schließer / NO ) durch Relais	
	2		
	3	Positiv ( + )	4-20 mA Eingangssignal
	4	Negativ ( - )	
	5	Eingang Fernbedienung(Start-Stop)	
	6		
	7	Eingang Temperaturfühler	
	8		
	9	Eingang Flusssensor	
	10		
B	Eingang Füllstandskontrolle		

## Programmierenü Athena AT. PR

Durch über drei Sekunden langes Drücken der Taste  erhalten Sie Zugriff auf die Programmierung. Über die Tasten   können Sie die Menüpunkte durchblättern. Über die Taste  erhalten Sie Zugriff auf die Veränderungen.

Werkseitig ist die Pumpe auf den Konstant-Modus programmiert. Die Pumpe kehrt nach 1 Minute Inaktivität automatisch zum Betriebs-Modus zurück. In diesem Fall werden etwaig eingegebene Daten nicht gespeichert.

Über die Taste  verlassen Sie die Programmierstufen. Bei Verlassen der Programmierung wird auf dem Display folgendes angezeigt:

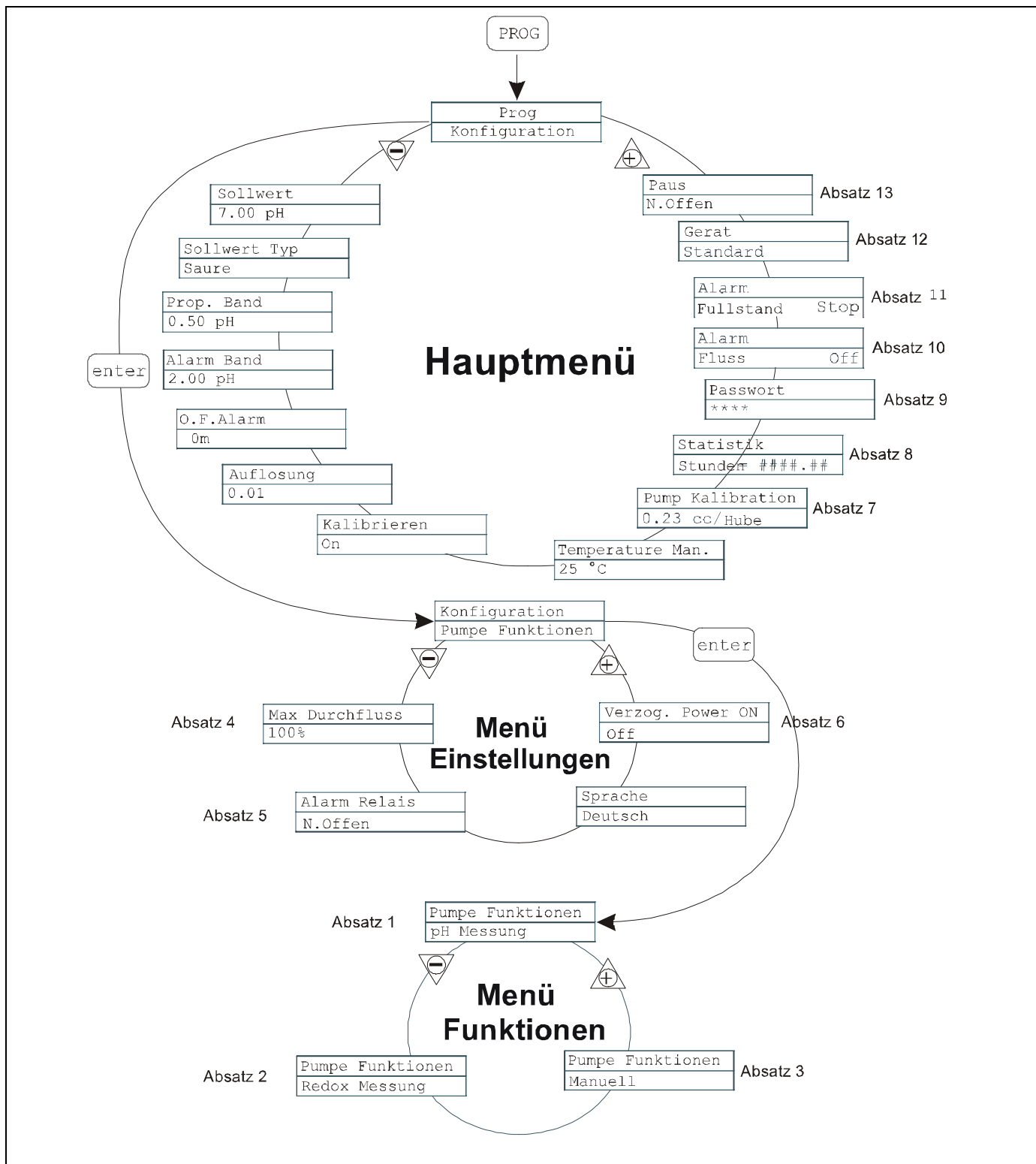
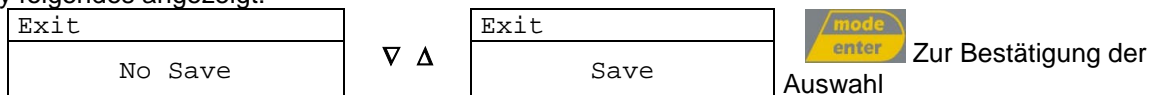

# Sprachauswahl

Programmierung	Funktionsweise
	<p>Ermöglicht die Sprachauswahl. Werkseitig ist die Sprache Englisch eingestellt.</p> <p>Durch Drücken von  erhalten Sie Zugriff auf die Veränderung. Stellen Sie dann über die Tasten   den Wert ein. Über  bestätigen Sie und werden zum Hauptmenü zurückgeleitet.</p>

# Absatz 1 –Manuelle Dosierung

Programmierung	Funktionsweise
	<p>Die Pumpe arbeitet im Konstant-Modus. Die Förderleistung wird manuell geregelt. Durch gleichzeitiges Drücken der Tasten   wird die Förderleistung erhöht bzw. über die Tasten   verringert.</p>

Anzeige während des Betriebs	Anzeige während der Einstellung (Taste MODE)
<div style="display: flex; justify-content: space-between;"> <div style="border: 1px solid black; padding: 5px;"> <p><b>Betriebs-Modus</b></p> <ul style="list-style-type: none"> <li>• Man = Manuell</li> </ul> </div> <div style="border: 1px solid black; padding: 5px;"> <p><b>Zustand Durchflusssensor</b></p> </div> <div style="border: 1px solid black; padding: 5px;"> <p><b>Wert der laufenden Dosierung (hängt von der ausgewählten Messeinheit ab)</b></p> <ul style="list-style-type: none"> <li>• %, Frequenz, l/h, Gph, ml/m</li> </ul> </div> </div> <div style="border: 1px solid black; padding: 10px; margin: 10px 0; text-align: center;"> <p>MAN <b>F</b> P100%</p> <p>Lev Stop</p> </div> <div style="display: flex; justify-content: space-between;"> <div style="border: 1px solid black; padding: 5px;"> <p><b>Alarmer und Zustände</b></p> <ul style="list-style-type: none"> <li>• Liv = Füllstandsalarm</li> <li>• Fls = Durchflussalarm</li> </ul> </div> <div style="border: 1px solid black; padding: 5px;"> <p><b>Zustand der Pumpe</b></p> <ul style="list-style-type: none"> <li>• Leer = Pumpenstart</li> <li>• Stop = Pumpe steht</li> <li>• Pause = Pumpe in Pause</li> </ul> </div> </div>	<div style="border: 1px solid black; padding: 5px;"> <p><b>Betriebs-Modus</b></p> <ul style="list-style-type: none"> <li>• Zeigt den der Frequenz entsprechenden Wert an</li> </ul> </div> <div style="border: 1px solid black; padding: 10px; margin: 10px 0; text-align: center;"> <p>F320s/m P100%</p> </div> <div style="border: 1px solid black; padding: 5px;"> <p><b>Wert der laufenden Dosierung</b></p> <ul style="list-style-type: none"> <li>• Verändert die maximale Förderleistung durch gleichzeitiges Drücken der Tasten + und -</li> </ul> </div>

Absatz 2 – Dosierung proportional zur Messung des pH-Werts (werkseitige Einstellung)

Programmierung	Funktionsweise
<pre> PROG Konfiguration enter Konfiguration Pumpe Funktionen enter Pumpe Funktionen pH Messung enter Sollwert 7.00 pH Sollwert Typ Saure Prop. Band 0.50 pH Alarm Band 2.00 pH O.F.Alarm 0m Auflösung 0.01 Kalibrieren On Temperatur Man 25 °C                 </pre>	<p>Die Pumpe misst und überwacht den pH-Wert durch die aufeinander folgende Programmierung folgender Werte: Set-Point, Art des Set-Points, Proportionalbereich und Alarmbereich.</p> <p>Art des Set-Points: sauer</p> <p>Art des Set-Points: alkalisch</p> <p>Ferner kann folgendes programmiert werden:</p> <ul style="list-style-type: none"> <li>- Die O.F.A.-Zeit (Over Feed Alarm) in Minuten, d.h. einen Zeitraum, über den hinaus eine Alarmsignal aktiviert wird, wenn die Messung des pH-Werts den Set-Point nicht erreicht.</li> <li>- Die Auflösung der Messung (1 oder 2 Dezimalstellen)</li> <li>- Deaktivierung/Aktivierung des Kalibrierverfahrens</li> <li>- Manueller Wert der Temperatur in °C (werkseitige Einstellung) oder °F</li> </ul> <p>Die Höchsthäufigkeit kann während des Betriebs verändert werden. Durch gleichzeitiges Drücken der Tasten  wird die Förderleistung erhöht bzw. über die Tasten  verringert.</p>

Anzeige während des Betriebs	Anzeige während der Einstellung (Taste MODE)
<div style="display: flex; justify-content: space-between;"> <div style="border: 1px solid black; padding: 5px;"> <p>• Art des Set-Points; sauer/alkalisch</p> </div> <div style="border: 1px solid black; padding: 5px; text-align: center;"> <p>Zustand des Durchflusssensors</p> </div> <div style="border: 1px solid black; padding: 5px;"> <p>pH-Messwert</p> </div> </div> <div style="border: 1px solid black; padding: 5px; margin-top: 10px; text-align: center;"> <p>Alca F 7.00pH Lev Stop P100%</p> </div> <div style="display: flex; justify-content: space-between; margin-top: 10px;"> <div style="border: 1px solid black; padding: 5px;"> <p><u>Alarmer und Zustände</u></p> <ul style="list-style-type: none"> <li>• Cal = Kalibrierung nicht durchgeführt</li> <li>• Lev = Füllstandsalarm</li> <li>• Flw = Durchflussalarm</li> <li>• Alm = Messung ausserhalb des Alarmbereichs</li> </ul> </div> <div style="border: 1px solid black; padding: 5px;"> <p><u>Zustand der Pumpe</u></p> <ul style="list-style-type: none"> <li>• Leer = Pumpenstart</li> <li>• Stop = Pumpe steht</li> <li>• Pause = Pumpe in Pause</li> </ul> </div> <div style="border: 1px solid black; padding: 5px;"> <p><u>Wert der laufenden Dosierung</u> (hängt von der ausgewählten Messeinheit ab)</p> <ul style="list-style-type: none"> <li>• %, Frequenz, l/h, Gph, ml/m</li> </ul> </div> </div>	<div style="border: 1px solid black; padding: 5px; margin-bottom: 10px;"> <p><u>Der Reihe nach wird angezeigt:</u></p> <ul style="list-style-type: none"> <li>• SP = Set-Point-Wert</li> <li>• BP = Wert Proportionalbereich</li> <li>• BA = Wert Alarmbereich</li> <li>• OFA = O.F.A.-Wert</li> <li>• Temp = Temperaturwert</li> </ul> </div> <div style="border: 1px solid black; padding: 5px; margin-bottom: 10px; text-align: center;"> <p>SP 7.00pH 4.50pH P100%</p> </div> <div style="border: 1px solid black; padding: 5px; text-align: center;"> <p>Messwert</p> </div> <div style="border: 1px solid black; padding: 5px; margin-top: 10px;"> <p><u>Eingestellter Höchstwert der Dosierung</u> (hängt von der ausgewählten Messeinheit ab)</p> <ul style="list-style-type: none"> <li>• %, Frequenz, l/h, Gph, ml/m</li> </ul> </div>

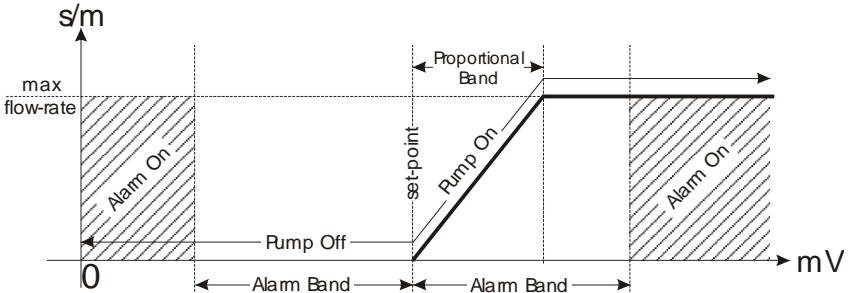
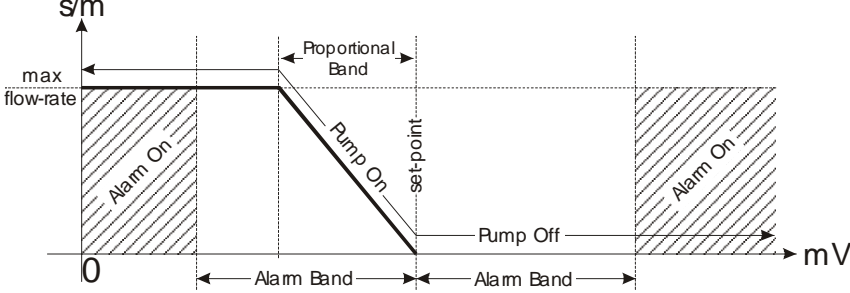

**Absatz 3 – Dosierung proportional zur Messung des Redox-Potentials (O.R.P.)**

Programmierung	Funktionsweise
<pre> PROG PROG Konfiguration enter Konfiguration Pumpe Funktionen enter Pumpe Funktionen Redox Messung enter Sollwert 560 mV enter Sollwert Typ Hoch enter Prop. Band 50 mV enter Alarm Band 200 mV enter O.F.Alarm 0m enter Kalibrieren On enter </pre>	<p>Die Pumpe misst und überwacht den pH-Wert durch die aufeinander folgende Programmierung folgender Werte: Set-Point, Art des Set-Points, Proportionalbereich und Alarmbereich.</p> <p>Art des Set-Points: Höchstwert</p>  <p>Art des Set-Points: Tiefstwert</p>  <p>Ferner kann folgendes programmiert werden:</p> <ul style="list-style-type: none"> <li>- Die O.F.A.-Zeit (Over Feed Alarm) in Minuten, d.h. einen Zeitraum, über den hinaus eine Alarmsignal aktiviert wird, wenn die Messung des pH-Werts den Set-Point nicht erreicht.</li> <li>- Die Auflösung der Messung (1 oder 2 Dezimalstellen)</li> <li>- Deaktivierung/Aktivierung des Kalibrierverfahrens</li> </ul> <p>Die Höchstfrequenz kann während des Betriebs verändert werden. Durch gleichzeitiges Drücken der Tasten <b>mode enter</b> <b>+</b> wird die Förderleistung erhöht bzw. über die Tasten <b>mode enter</b> <b>-</b> verringert.</p>

Anzeige während des Betriebs	Anzeige während der Einstellung (Taste MODE)
<p>• Art des Set-Points: High/Low</p> <p><b>Zustand des Durchflusssensors</b></p> <p><b>Messwert des Redox-Potentials</b></p> <p><b>Alarmer und Zusatände</b></p> <ul style="list-style-type: none"> <li>• Cal = Kalibrierung nicht durchgeführt</li> <li>• Lev = Füllstandsalarm</li> <li>• Flw = Durchflussalarm</li> <li>• Alm = Messung ausserhalb des Alarmbereichs</li> <li>• OFA = O.F.A.-Alarm</li> </ul> <p><b>Zustand der Pumpe</b></p> <ul style="list-style-type: none"> <li>• Leer = Pumpenstart</li> <li>• Stop = Pumpe steht</li> <li>• Pause = Pumpe in Pause</li> </ul> <p><b>Wert der laufenden Dosierung</b> (hängt von der ausgewählten Messeinheit ab)</p> <ul style="list-style-type: none"> <li>• %, Frequenz, l/h, Gph, ml/m</li> </ul> <p>High 560mV Lev Stop P100%</p>	<p>Der Reihe nach wird angezeigt:</p> <ul style="list-style-type: none"> <li>• SP = Set-Point-Wert</li> <li>• BP = Wert Proportionalbereich</li> <li>• BA = Wert Alarmbereich</li> <li>• OFA = O.F.A.-Wert</li> </ul> <p>SP 560mV 450mV P100%</p> <p>Messwert</p> <p><b>Eingestellter Höchstwert der Dosierung</b> (hängt von der ausgewählten Messeinheit ab)</p> <ul style="list-style-type: none"> <li>• %, Frequenz, l/h, Gph, ml/m</li> </ul>

#### Absatz 4 – Einstellung der maximalen Förderleistung

Programmierung	Funktionsweise
	<p>Ermöglicht die Einstellung der maximalen Förderleistung, die die Pumpe erreichen kann, und der programmierte Betriebs-Modus (% oder Frequenz) wird zur Anzeige der Förderleistung in der Standardmeseinheit. Durch Drücken von  erhalten Sie Zugriff auf die Veränderung.</p> <p>Stellen Sie dann über die Tasten   den Wert ein.</p> <p>Über  bestätigen Sie und werden zum Hauptmenü zurückgeleitet</p>

#### Absatz 5 – Einstellung Alarmrelais

Programmierung	Funktionsweise
	<p>Dient zur Einstellung des Alarmrelais auf geöffnet (werkseitige Einstellung) oder geschlossen, wenn keine Alarmsituation vorliegt.</p> <p>Durch Drücken von  erhalten Sie Zugriff auf die Veränderung. Stellen Sie dann über die Tasten   den Wert ein. Über  bestätigen Sie und werden zum Hauptmenü zurückgeleitet</p>

#### Absatz 6 – Einstellung der Einschaltverzögerung

Programmierung	Funktionsweise
	<p>Mit dieser Funktion kann man eine Einschaltverzögerung des Pumpenbetriebs einstellen. Diese Verzögerung tritt nur dann ein, wenn die Pumpe durch Unterbrechung der Stromversorgung aus- und wieder eingeschaltet wird.</p> <p>Diese Einstellung kann deaktiviert werden, indem man sie auf Off (werkseitige Einstellung) stellt, oder man wählt eine Verzögerung zwischen 1 und 60 Minuten.</p> <p>Bei aktivierter Einschaltverzögerung blinken die Alarm- und Impuls-Led während der eingestellten Zeit gleichzeitig (1 Sek. On – 1 Sek. Off) und auf dem Display wird der Countdown der verbleibenden Sekunden angezeigt. Steht die Pumpe auf Stopp werden nur die blinkenden Leds angezeigt. Die Funktion kann während der Verzögerungszeit über das Menü auf OFF gestellt und somit deaktiviert werden.</p> <p>Mit der Taste  gelangt man zur Bearbeitung, dann mit den Tasten   den Wert eingeben. Mit  bestätigen und zurück zum Hauptmenü.</p>

## Absatz 7 – Kalibrierung der Förderleistung

Programmierung	Funktionsweise
	<p>Im Hauptmenü erscheint das gespeicherte Hubvolumen. Es kann auf zwei Arten kalibriert werden:</p> <p>MANUELL – Geben Sie über die Tasten   manuell das Hubvolumen ein und bestätigen Sie über .</p> <p>AUTOMATISCH – Die Pumpe führt 100 Hübe aus, die über die Taste  gestartet werden. Wenn diese Hübe ausgeführt worden sind, geben Sie über die Tasten   die von der Pumpe angesaugte Menge ein und bestätigen Sie über .</p> <p>Der eingegebene Wert wird bei der Berechnung der Förderleistungen verwendet.</p>

## Absatz 8 – Statistiken

Programmierung	Funktionsweise
	<p>Im Hauptmenü werden die Betriebsstunden der Pumpe angezeigt. Durch Drücken der Taste  erhalten Sie Zugriff auf die anderen Statistiken:</p> <ul style="list-style-type: none"> <li>- Strokes = Anzahl der von der Pumpe ausgeführten Hübe</li> <li>- Q.ty(L) = in Litern ausgedrückte von der Pumpe dosierte Menge; dieser Wert wird entsprechend des gespeicherten Hubvolumens berechnet.</li> <li>- Power = Anzahl der Pumpenstarts</li> <li>- Reset = über die Tasten   können Sie die Uhr auf Null stellen (YES) oder nicht (NO), über  bestätigen Sie.</li> </ul> <p>Durch Drücken von  gelangen Sie zum Hauptmenü zurück.</p>

## Absatz 9 – Passwort

Programmierung	Funktionsweise
	<p>Durch Eingabe des Passworts erhalten Sie Zugriff auf die Programmierung und können sich alle eingegebenen Werte ansehen. Jedes Mal wenn Sie versuchen, diese Werte zu verändern, erscheint ein eigener Passwortdialog. Die blinkende Linie zeigt die veränderbare Nummer an.</p> <p>Wählen Sie über die Taste  die Nummer aus (zwischen 1 und 9), wählen Sie über die Taste  die Nummer aus, die verändert werden soll, und bestätigen Sie anschließend über .</p> <p>Durch Eingabe von "0000" (werkseitige Einstellung) wird die Passwortabfrage übersprungen.</p>

### Absatz 10 – Durchflussalarm

Programmierung	Funktionsweise
	<p>Ermöglicht die Aktivierung (Deaktivierung) des Durchflusssensors.</p> <p>Wenn er einmal aktiviert ist (ON), erhalten Sie durch Drücken der Taste  Zugriff auf den Abfragedialog, wie viele Signale die Pumpe abwartet, bevor Sie einen Alarm auslöst. Durch Drücken von  beginnt die Nummer zu blinken. Stellen Sie dann über die Tasten   den Wert ein. Über  bestätigen Sie. Durch Drücken von  werden Sie zum Hauptmenü zurückgeleitet.</p>

### Absatz 11 – Füllstandsalarm

Programmierung	Funktionsweise
	<p>Ermöglicht die Einstellung des Zeitpunkts, an dem der Füllstandsalarm aktiviert, d.h. die Dosierung blockiert wird (Stop), oder einfach nur das Alarmsignal aktiviert werden soll, ohne dabei die Dosierung zu blockieren.</p> <p>Durch Drücken von  erhalten Sie Zugriff auf die Veränderung. Stellen Sie dann über die Tasten   die Alarmart ein. Über  bestätigen Sie. Durch Drücken von  werden Sie zum Hauptmenü zurückgeleitet.</p>

### Absatz 12 – Anzeigeeinheit der Förderleistung

Programmierung	Funktionsweise
	<p>Ermöglicht die Einstellung der Maßeinheit der Dosierung über eine Anzeige auf dem Display.</p> <p>Durch Drücken von  erhalten Sie Zugriff auf die Veränderung. Stellen Sie dann über die Tasten   die gewünschte Maßeinheit ein, L/H (Liter/Stunde), GpH (Gallone/Stunde), ml/m (Milliliter/Minute) oder die Standardeinstellung (% oder Frequenz, je nach Einstellung).</p> <p>Über  bestätigen Sie und werden zum Hauptmenü zurückgeleitet</p>

### Absatz 13 - Einstellung Pause

Programmierung	Funktionsweise
	<p>Steuereingang: Pumpe Stop / Start. Werkseinstellung: Bei Schließerkontakt (elektrisch leitende Verbindung zwischen beiden Anschlussklemmen) Pumpenstop.</p> <p>Durch Drücken von  erhalten Sie Zugriff auf die Veränderung.</p> <p>Stellen Sie dann über die Tasten   den Wert ein (N. OFFEN oder N. GESCHLOSSEN).</p> <p>Über  bestätigen Sie und werden zum Hauptmenü zurückgeleitet.</p>

### Menü zur Kalibrierung des pH-Wert

Durch 3 Sekunden langes Drücken der Taste CAL erhalten Sie Zugriff auf das Kalibriermenü. Wenn die Kalibrierung während der Programmierung ausgeschlossen wurde, wird auf dem Display folgendes angezeigt:

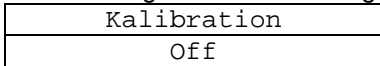

Wenn die Kalibrierung aktiv ist:

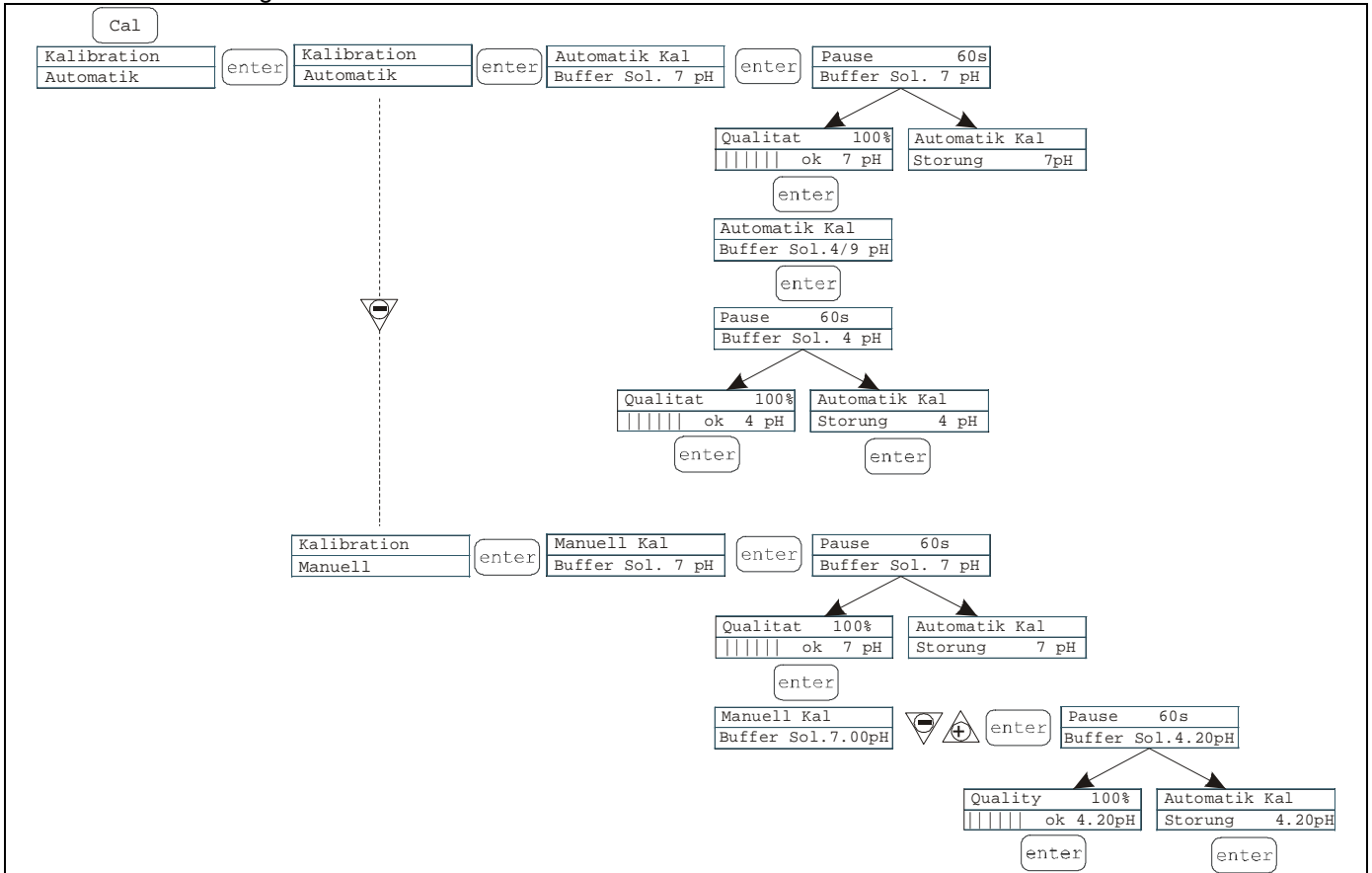

Es ist möglich, die automatische oder die manuelle Kalibrierung zu wählen. In beiden Fällen erfolgt die Kalibrierung auf den pH-Wert 7 automatisch.

- Automatische Kalibrierung:

Auf dem Display erscheint der Wert der Pufferlösung. Die Sonde in das Fläschchen einführen, durch Drücken von

erscheint auf dem Display die Rückwärtszählung der für die vollständige Durchführung der Kalibrierung erforderlichen 60 Sekunden. Wenn die Qualität des Abgleichs unter 50% liegt, erscheint eine Fehlermeldung auf

dem Display und durch Drücken von verlassen Sie die Kalibrierung (nach 4 Sekunden verlässt die Pumpe die Kalibrierung automatisch). Wenn die Qualität des Abgleichs über 50% liegt, wird der Wert auf dem Display

angezeigt und durch Drücken von wird die Pufferlösung mit pH-Wert 4 oder 9 gefordert; an diesem Punkt ist das Verfahren identisch zum zuvor liegenden Verfahren.

- Manuelle Kalibrierung:

Wenn auf dem Display der Wert der Pufferlösung erscheint, die Sonde in das Fläschchen einführen, durch

Drücken von erscheint auf dem Display die Rückwärtszählung der für die vollständige Durchführung der Kalibrierung erforderlichen 60 Sekunden. Wenn die Qualität des Abgleichs unter 50% liegt, erscheint eine

Fehlermeldung auf dem Display und durch Drücken von verlassen Sie die Kalibrierung (nach 4 Sekunden verlässt die Pumpe die Kalibrierung automatisch). Wenn die Qualität des Abgleichs über 50% liegt, wird der Wert

auf dem Display angezeigt und durch Drücken von blinkt der pH-Wert 7.00 auf dem Display. Geben Sie

über die Tasten den Wert der zur Verfügung stehenden Pufferlösung ein, bestätigen Sie durch Drücken

von und starten Sie das Kalibrierverfahren wie zuvor.

## Menü zur Kalibrierung des Redox-Potentials (O.R.P.)

Durch 3 Sekunden langes Drücken der Taste CAL erhalten Sie Zugriff auf das Kalibriermenü, wenn die Kalibrierung während der Programmierung ausgeschlossen wurde, wird auf dem Display folgendes angezeigt:

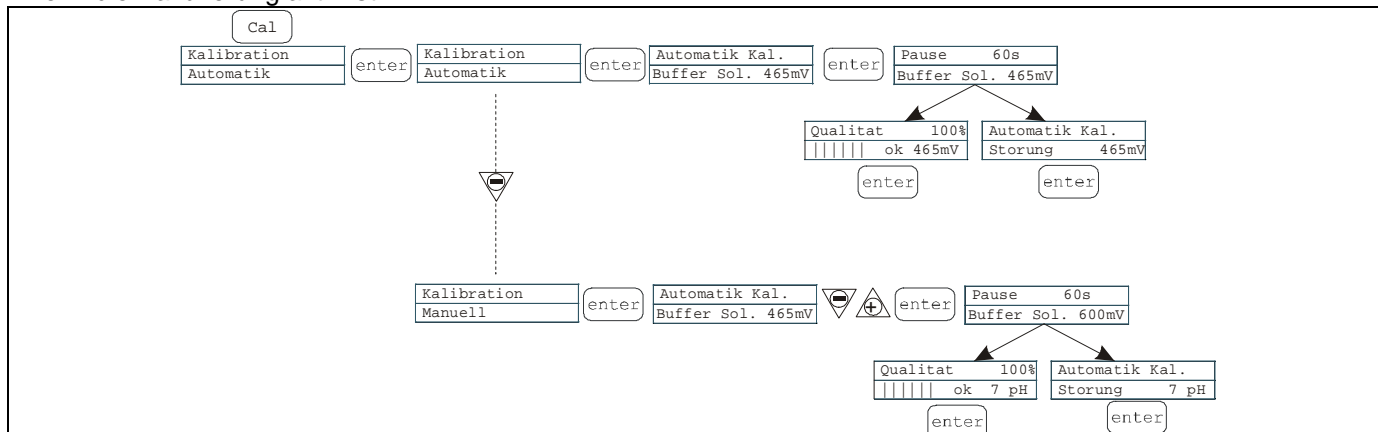

Kalibration
Off

Wenn die Kalibrierung aktiv ist:







Es ist möglich, die automatische oder die manuelle Kalibrierung zu wählen.



- Automatische Kalibrierung:

Auf dem Display erscheint der Wert der Pufferlösung. Die Sonde in das Fläschchen einführen, durch Drücken von  erscheint auf dem Display die Rückwärtszählung der für die vollständige Durchführung der Kalibrierung erforderlichen 60 Sekunden. Wenn die Qualität des Abgleichs unter 50% liegt, erscheint eine Fehlermeldung auf dem Display und durch Drücken von  verlassen Sie die Kalibrierung (nach 4 Sekunden verlässt die Pumpe die Kalibrierung automatisch). Wenn die Qualität des Abgleichs über 50% liegt, wird der Wert auf dem Display angezeigt und durch Drücken von  wird das Verfahren zu Ende geführt.

- Manuelle Kalibrierung:

Auf dem Display erscheint der Wert der Pufferlösung. Die Sonde in das Fläschchen einführen, durch Drücken von  blinkt der Wert 465mV auf dem Display. Führen Sie die Sonde in Ihre Lösung ein und zeigen Sie dann über die Tasten   den Wert der zur Verfügung stehenden Lösung an. Durch Drücken von  bestätigen Sie und starten das Kalibrierverfahren wie zuvor.

## Alarmer

Anzeige	Ursache	Unterbrechung				
Alarm-Led leuchtet kontinuierlich Der Schriftzug Lev blinkt Bsp.: <table border="1" style="display: inline-table; vertical-align: middle;"> <tr> <td>Man</td> <td></td> </tr> <tr> <td>Lev</td> <td>P100%</td> </tr> </table>	Man		Lev	P100%	Alarm Füllstand nicht ausreichend, ohne Unterbrechung des Pumpenbetriebs	Flüssigkeit nachfüllen
Man						
Lev	P100%					
Alarm-Led leuchtet kontinuierlich Der Schriftzug Lev und Stop blinkt Bsp.: <table border="1" style="display: inline-table; vertical-align: middle;"> <tr> <td>Man</td> <td></td> </tr> <tr> <td>Lev Stop</td> <td>P100%</td> </tr> </table>	Man		Lev Stop	P100%	Alarm Füllstand nicht ausreichend, mit Unterbrechung des Pumpenbetriebs	Flüssigkeit nachfüllen
Man						
Lev Stop	P100%					
Alarm-Led leuchtet kontinuierlich Der Schriftzug Flw blinkt Bsp.: <table border="1" style="display: inline-table; vertical-align: middle;"> <tr> <td>Man</td> <td><b>E</b></td> </tr> <tr> <td>Flu</td> <td>P100%</td> </tr> </table>	Man	<b>E</b>	Flu	P100%	Durchflussalarm aktiv, die Pumpe hat nicht die programmierten Signale vom Durchflusssensor empfangen.	Die Taste  drücken
Man	<b>E</b>					
Flu	P100%					
Bsp.: <table border="1" style="display: inline-table; vertical-align: middle;"> <tr> <td>Param. Störung</td> <td></td> </tr> <tr> <td>Programm störung</td> <td></td> </tr> </table>	Param. Störung		Programm störung		Kommunikationsfehler mit dem EEPROM	Die Taste  drücken, um auf die Default-Parameter rückzustellen.
Param. Störung						
Programm störung						
Der Schriftzug „OFA“ blinkt Der Schriftzug „Stop“ blinkt Bsp.: <table border="1" style="display: inline-table; vertical-align: middle;"> <tr> <td>Hoch</td> <td>475 mV OFA</td> </tr> <tr> <td>Stop</td> <td>P 75%</td> </tr> </table>	Hoch	475 mV OFA	Stop	P 75%	O.F.A.-Alarm	Die Taste  drücken, um das Blinken des Schriftzugs Stop anzuhalten. Die Taste erneut drücken, um die Pumpe wieder zu starten.
Hoch	475 mV OFA					
Stop	P 75%					
Der Schriftzug „Alm“ blinkt Bsp.: <table border="1" style="display: inline-table; vertical-align: middle;"> <tr> <td>Hoch</td> <td>475 mV Alm</td> </tr> <tr> <td>P</td> <td>75%</td> </tr> </table>	Hoch	475 mV Alm	P	75%	Der von der Sonde gemessene Wert befindet sich außerhalb des eingestellten Alarmbereichs	Die richtige Einstellung des Parameters „Alarmbereich“ in der Programmierung überprüfen.
Hoch	475 mV Alm					
P	75%					
Der Schriftzug „OFA“ blinkt Bsp.: <table border="1" style="display: inline-table; vertical-align: middle;"> <tr> <td>Hoch</td> <td>475 mV Cal</td> </tr> <tr> <td>P</td> <td>75%</td> </tr> </table>	Hoch	475 mV Cal	P	75%	Alarm Sonde nicht kalibriert	Die Kalibrierung der Sonde vornehmen.
Hoch	475 mV Cal					
P	75%					

### Panel de control – Athena AT. PR

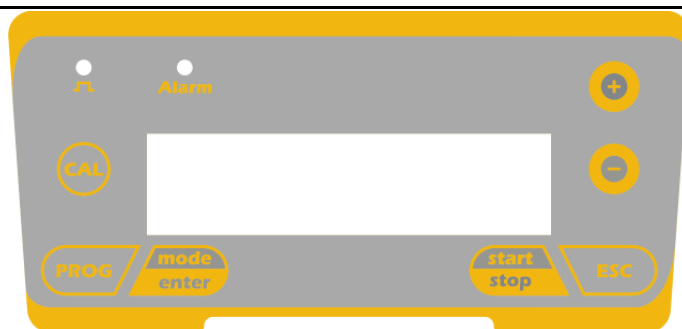



	Acceso al menú de programación.
	Durante el funcionamiento de la bomba: Si se pulsa visualiza cíclicamente en el display los valores programados; si se pulsa simultáneamente a las teclas   aumenta o disminuye un valor dependiente del modo de funcionamiento escogido. En programación ejerce la función “enter”, es decir, confirma la entrada en los diferentes niveles del menú y las modificaciones en el interior de los mismos.
	Pone en marcha y detiene la bomba. En condiciones de alarma de nivel (sólo función de alarma), de alarma de flujo y alarma <i>memory</i> activas, desactiva la señalización en el display.
	Para “salir” de los diferentes niveles del menú. Antes de salir definitivamente de la programación se accede a la solicitud de memorización de las modificaciones.
	Acceso al menú de calibración de la bomba. Si está en modo OFF, el menú de calibración no se activa.
	Desplaza los menús hacia arriba o aumenta los valores numéricos a modificar. En modo Batch puede poner en marcha la dosificación.
	Desplaza los menús hacia abajo o disminuye los valores numéricos a modificar.
	Led verde parpadeante durante la dosificación.
	Led rojo que se enciende durante las diferentes situaciones de alarma.

### Conexiones eléctricas

	1	Relé de Alarma	
	2		
	3	Pole +	Entrada señal 4-20
	4	Pole -	
	5	Entrada control externo (start-stop)	
	6		
	7	Entrada señal en frecuencia (contador emisor de impulsos)	
	8		
	9	Entrada sensor de Flujo	
	10		
B	Entrada sonda de nivel		



## Menú de programación Athena AT. PR

Pulsando la tecla  durante más de tres segundos se accede a la programación. Con las teclas  

se pueden desplazar las voces del menú, con la tecla  se accede a las modificaciones. En la fábrica la bomba se programa en modo constante. La bomba vuelve automáticamente al modo de funcionamiento después de 1 minuto de inactividad. En este caso los datos que se han introducido no serán memorizados. Con la tecla

 se sale de los niveles de la programación. Al salir de la programación el display visualiza:

Exit
No Save

▽ ▲

Exit
Save



para confirmar la elección

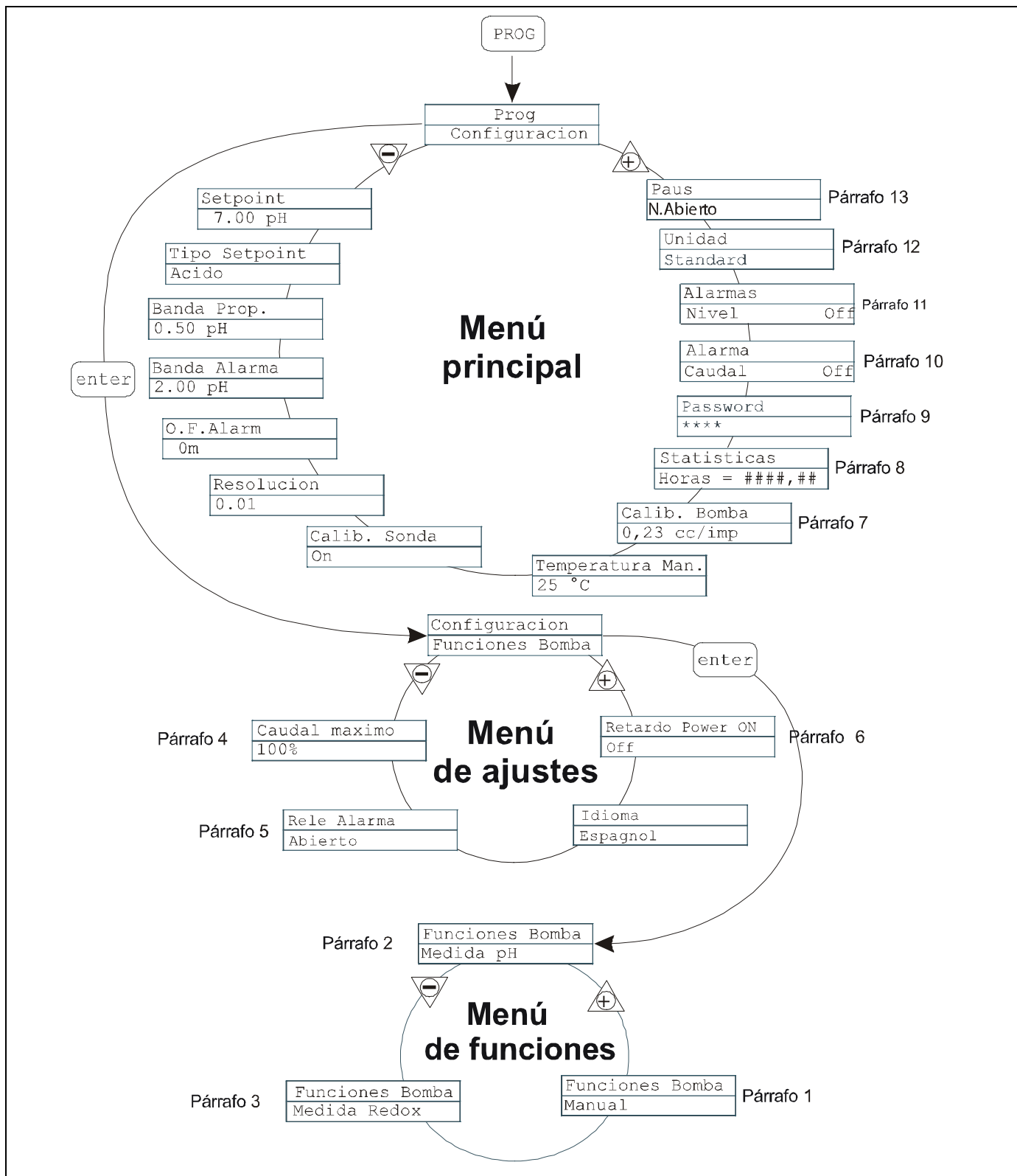

**Programación del idioma**







Programación	Funcionamiento
<pre> graph TD     A[PROG] --&gt; B[PROG Configuration]     B -- enter --&gt; C[Configuration Pump Functions]     C --&gt; D[Max flow rate P100%]     D --&gt; E[Alarm Relay N.Open]     E --&gt; F[Language English]     F -- enter --&gt; G[ ]     </pre>	<p>Permite seleccionar el idioma, en la fábrica la bomba se programa en inglés. Pulsando la tecla  se accede a la modificación, con las teclas   se programa el valor. Con la tecla  se confirma y se vuelve al menú principal.</p>

**Párrafo 1 – Dosificación manual**

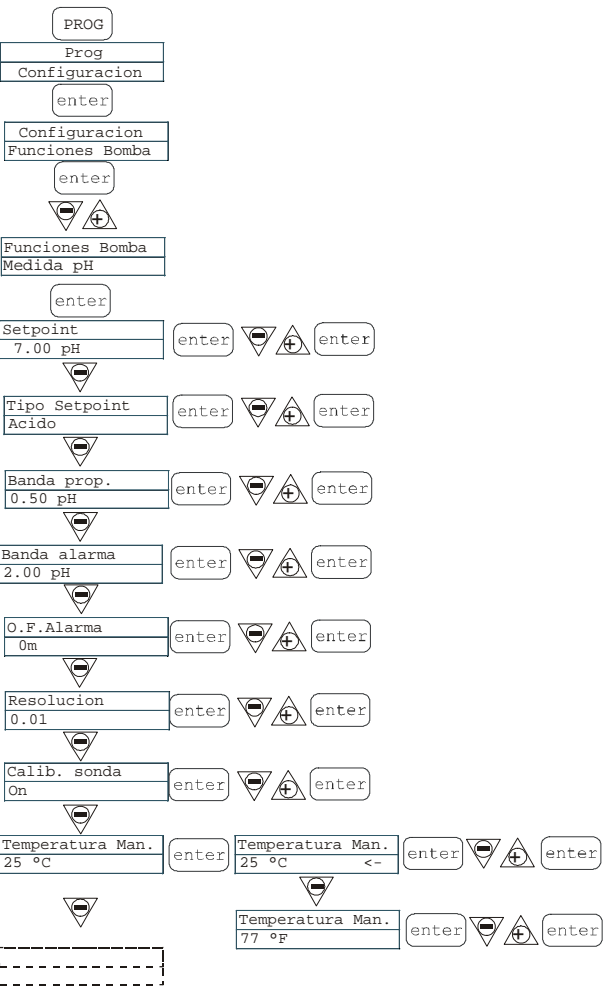
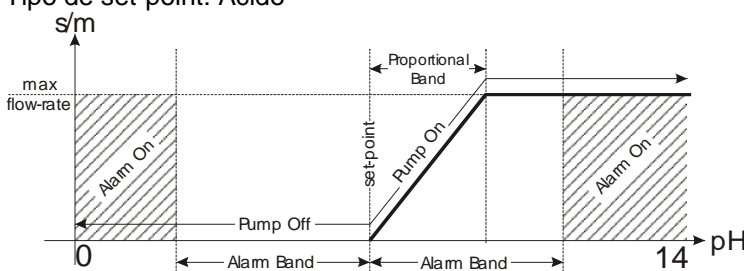
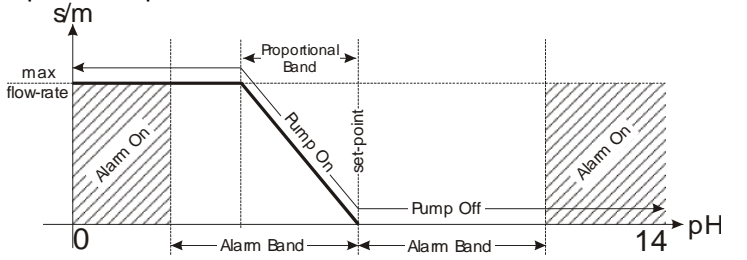
Programación	Funcionamiento
<pre> graph TD     A[PROG] --&gt; B[PROG Configuracion]     B -- enter --&gt; C[Configuracion Funciones Bomba]     C -- enter --&gt; D[Funciones Bomba Manual]     D -- enter --&gt; E[ ]     </pre>	<p>La bomba trabaja en modo constante. El caudal se regula manualmente pulsando simultáneamente las teclas   para aumentar el caudal o las teclas   para disminuirlo.</p>

Visualización durante el funcionamiento	Visualización en programación (tecla MODE)
<p><b>Modo de funcionamiento</b></p> <ul style="list-style-type: none"> <li>Man = Manual</li> </ul> <p><b>Estado del sensor de FLUJO</b></p> <p><b>Estado de la bomba</b></p> <ul style="list-style-type: none"> <li>Vacío = bomba en start</li> <li>Stop = bomba parada</li> <li>Pausa = bomba en pausa</li> </ul> <p><b>Alarmas y estados</b></p> <ul style="list-style-type: none"> <li>Liv = Alarma de nivel</li> <li>Fls = Alarma de flujo</li> </ul> <p><b>Valor de la dosificación en curso</b> (depende de la unidad de medida seleccionada)</p> <ul style="list-style-type: none"> <li>Porcentaje, Frecuencia, l/h, Gph, ml/m</li> </ul>	<p><b>Modo de funcionamiento</b></p> <ul style="list-style-type: none"> <li>Visualiza el valor correspondiente de la frecuencia</li> </ul> <p><b>Valor de la dosificación en curso</b></p> <ul style="list-style-type: none"> <li>Modifica el caudal máximo pulsando simultáneamente las teclas + o -</li> </ul>

**Párrafo 2 – Dosificación proporcional a la medida del pH (programación en la fábrica)**

Programación	Funcionamiento
	<p>La bomba mide y controla el valor del pH de una solución programando en secuencia: Set-point, tipo de set-point, banda proporcional y banda de alarma.</p> <p>Tipo de set-point: Ácido</p>  <p>Tipo de set-point: Alcalino</p>  <p>Además, se puede programar:</p> <ul style="list-style-type: none"> <li>- El tiempo O.F.A. (Over Feed Alarm) en minutos, es decir el tiempo después del cual se activa una señal de alarma si la medida del pH no alcanza el set-point.</li> <li>- La resolución de la medida (1 ó 2 cifras decimales).</li> <li>- Desactivación/activación del procedimiento de calibración.</li> <li>- Valor manual de la temperatura en °C (fábrica) o °F.</li> </ul> <p>La frecuencia máxima se puede modificar durante el funcionamiento pulsando simultáneamente las teclas   para aumentar el caudal, o las teclas    para disminuirlo.</p>

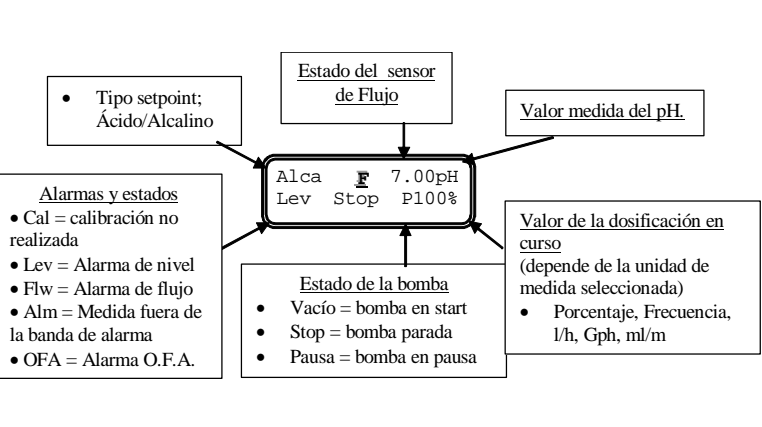
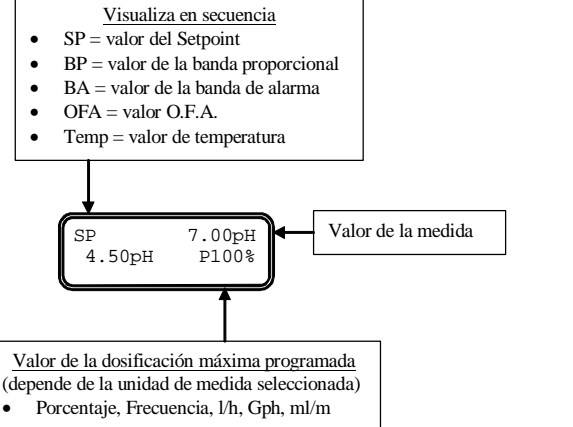
Visualización durante el funcionamiento	Visualización en programación (tecla MODE)
	<p><u>Visualiza en secuencia</u></p> <ul style="list-style-type: none"> <li>• SP = valor del Setpoint</li> <li>• BP = valor de la banda proporcional</li> <li>• BA = valor de la banda de alarma</li> <li>• OFA = valor O.F.A.</li> <li>• Temp = valor de temperatura</li> </ul> 

**Párrafo 3 – Dosificación Proporcional a la medida del potencial Redox (O.R.P.)**

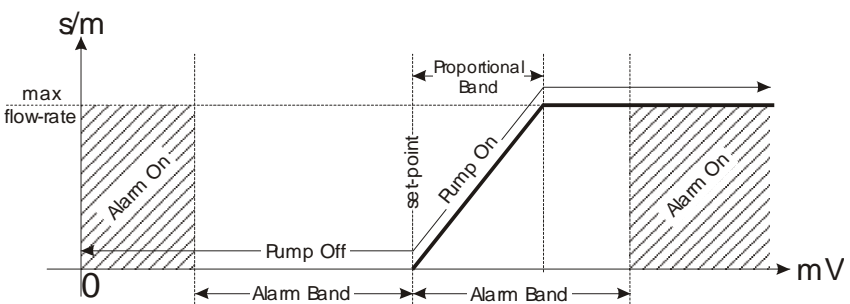
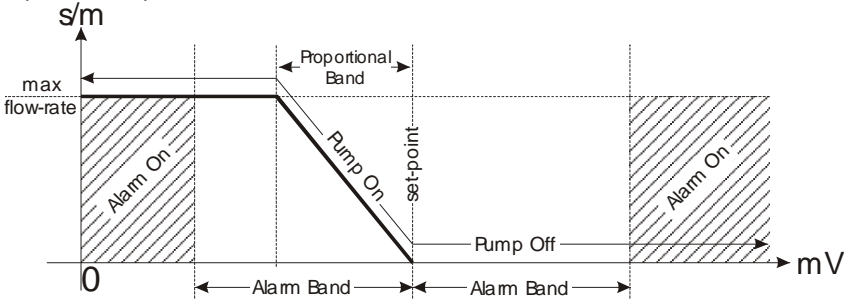
Programación	Funcionamiento
<pre> PROG Prog Configuracion enter Configuracion Funciones Bomba enter Funciones Bomba Medida Redox enter Setpoint 560 mV enter Tipo Setpoint Alto enter Banda prop. 50 mV enter Banda alarma 200 mV enter O.F. Alarme 0m enter Calib. sonda On enter                     </pre>	<p>La bomba mide y controla el valor del pH de una solución programando en secuencia: Set-point, tipo de set-point, banda proporcional y banda de alarma.</p> <p>Tipo de set-point: Máxima</p>  <p>Tipo de set-point: mínima</p>  <p>Además, se puede programar:</p> <ul style="list-style-type: none"> <li>- El tiempo O.F.A. (Over Feed Alarm) en minutos, es decir el tiempo después del cual se activa una señal de alarma si la medida del pH no alcanza el set-point.</li> <li>- La resolución de la medida (1 ó 2 cifras decimales).</li> <li>- Desactivación/activación del procedimiento de calibración.</li> </ul> <p>La frecuencia máxima se puede modificar durante el funcionamiento pulsando simultáneamente las teclas <b>mode enter</b> <b>+</b> para aumentar el caudal, o las teclas <b>mode enter</b> <b>-</b> para disminuirlo.</p>

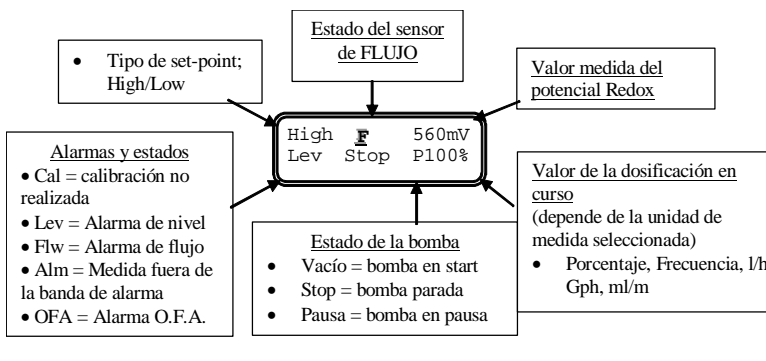
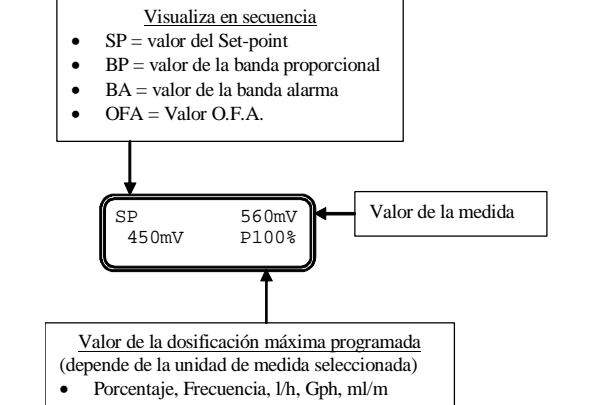
Visualización durante el funcionamiento	Visualización en programación (tecla MODE)
	

#### Párrafo 4 – Programación del caudal máximo

Programación	Funcionamiento
<p>The diagram illustrates the menu navigation for programming the maximum flow rate. It starts with 'PROG', followed by 'Configuracion' and 'Funciones Bomba'. The user then selects 'Caudal maximo P100%', which leads to a screen where the value 'F320s/m' is displayed. Navigation arrows and 'enter' buttons indicate the sequence of actions.</p>	<p>Permite programar el caudal máximo que la bomba puede alcanzar; el modo programado (% o frecuencia) se vuelve la visualización del caudal en la unidad de medida estándar. Pulsando la tecla  se accede a la modificación, después con las teclas   se programa el valor. Con la tecla  se confirma y se vuelve al menú principal.</p>

#### Párrafo 5 – Programación del relé de alarma

Programación	Funcionamiento
<p>The diagram shows the steps to program the alarm relay. It follows the same initial menu path as paragraph 4, reaching 'Funciones Bomba'. From there, it goes to 'Caudal maximo P100%' and then to 'Relé alarma Abierto'. The diagram uses arrows and 'enter' buttons to show the navigation flow.</p>	<p>Sirve para programar el relé de alarma en ausencia de una situación de alarma si está abierto (fábrica) o cerrado. Pulsando la tecla  se accede a la modificación, después con las teclas   se programa el valor. Con la tecla  se confirma y se vuelve al menú principal.</p>

#### Párrafo 6 – Configuración Retardo Power On

Programación	Funcionamiento
<p>The diagram details the programming steps for the Power On delay. It follows the previous menu items: 'Caudal Maximo P100%', 'Relé Alarma Abierto', 'Titoma Español', and finally 'Retardo Power ON Off'. The diagram uses arrows and 'enter' buttons to show the navigation flow.</p>	<p>Permite configurar un retardo del funcionamiento de la bomba al encenderse la misma. Este retardo tiene efecto sólo si la bomba se apaga y se vuelve a encender quitando la alimentación. La configuración puede deshabilitarse, Off (fábrica) o se puede configurar con un retardo de 1 a 60 minutos. Con el retardo activo, durante el tiempo configurado el led alarma y de impulso parpadean contemporáneamente (1 seg On – 1 seg Off) y la pantalla muestra el conteo en segundos. Si la bomba está en Stop, se visualizan sólo los led parpadeantes. Durante el tiempo de retardo puede desactivarse la función accediendo al menú, configurando el tiempo en Off. Presionando  se accede a la modificación, con las teclas   configuro el valor. Con  confirmo y vuelvo al menú principal.</p>

#### Párrafo 7 – Calibración del caudal

Programación	Funcionamiento
<p>The diagram shows the calibration process. It starts with 'Calib. Bomba 0,23 cc/colpo', then moves to 'Cal. Manual cc/impulso 0,23', followed by 'Cal. Automatica Inicio 100 imp.', 'Cal. Automatica Inyecciones 100', and finally 'Cal. Automatica ml 20'. The diagram uses arrows and 'enter' buttons to show the navigation flow.</p>	<p>En el menú principal aparece el valor de cc por golpe en memoria. Se puede calibrar en dos modos:  <b>MANUAL</b> – Introduciendo manualmente el valor de cc por golpe con las teclas   y confirmando con la tecla .</p> <p><b>AUTOMÁTICA</b> – La bomba realiza 100 golpes que se activan y confirman con la tecla , al final introducir la cantidad aspirada por la bomba con las teclas   y confirmar con la tecla . El dato introducido será utilizado en los cálculos de los caudales.</p>

**Párrafo 8 - Estadísticas**

Programación	Funcionamiento
	<p>En el menú principal visualiza las horas de funcionamiento de la bomba, pulsando la tecla  se accede a las demás estadísticas:</p> <ul style="list-style-type: none"> <li>- <i>Strokes</i> = Número de golpes realizados por la bomba.</li> <li>- <i>Q.ty (L)</i> = cantidad dosificada por la bomba expresada en litros; este valor se calcula en base al valor <i>cc/stroke</i> en memoria.</li> <li>- <i>Power</i> = Número de puestas en marcha de la bomba.</li> <li>- <i>Reset</i> = Con las teclas   se pueden poner en cero (YES) o no (NO) los contadores, con la tecla  se confirma. Pulsando la tecla  se vuelve al menú principal.</li> </ul>

**Párrafo 9 - Password**

Programación	Funcionamiento
	<p>Introduciendo la password se puede entrar en programación y ver todos los valores programados, pero cada vez que se quiera realizar una modificación será solicitada la password. La línea parpadeante indica el número que se puede modificar, con la tecla  se selecciona el número (de 1 a 9), con la tecla  se selecciona el número a modificar y con la tecla  se confirma. Programando "0000" (fábrica) la password queda excluida.</p>

**Párrafo 10 – Alarma de flujo**

Programación	Funcionamiento
	<p>Permite activar (desactivar) el sensor de flujo. Una vez activado (ON) pulsando la tecla  se accede a la solicitud de cuántas señales espera la bomba antes de entrar en alarma. Pulsando la tecla  el número parpadea, con las teclas   se puede programar el valor. Con la tecla  se confirma. Pulsando la tecla  se vuelve al menú principal.</p>

Párrafo 11 – Alarma de nivel

Programación	Funcionamiento
	<p>Permite programar la bomba cuando se activa la alarma del sensor de nivel, es decir, si se bloquea la dosificación (Stop) o simplemente activa la señal de alarma sin bloquear la dosificación. Pulsando  la tecla se accede a la modificación, con las teclas   se puede programar el tipo de alarma. Con la tecla  se confirma. Pulsando la tecla  se vuelve al menú principal.</p>

Párrafo 12 – Unidad de visualización del caudal

Programación	Funcionamiento
	<p>Permite programar la unidad de medida de la dosificación con el display en visualización. Pulsando la tecla  se accede a la modificación, con las teclas   se programa el tipo de unidad de medida, l/h (litros/hora), Gph (galones/hora), ml/m (mililitros/minuto) o estándar (% o frecuencia, según como haya sido programado). Con la tecla  se confirma y se vuelve al menú principal.</p>

Párrafo 13 – Programación Pausa

Programación	Funcionamiento
	<p>Entrada externa de paro de bomba. De fábrica el sistema llega configurado como Normalmente Abierto.</p> <p>Pulsando la tecla  se accede a la modificación, después con las teclas   se programa el valor ( N. ABIERTO o N. CERRADO.)</p> <p>Con la tecla  se confirma y se vuelve al menú principal.</p>

## Menú calibración pH

Pulsando la tecla CAL por tres segundos se entra en el menú calibración, si en programación la calibración ha sido excluida, en el display aparece:

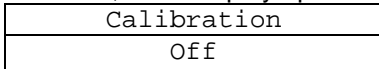

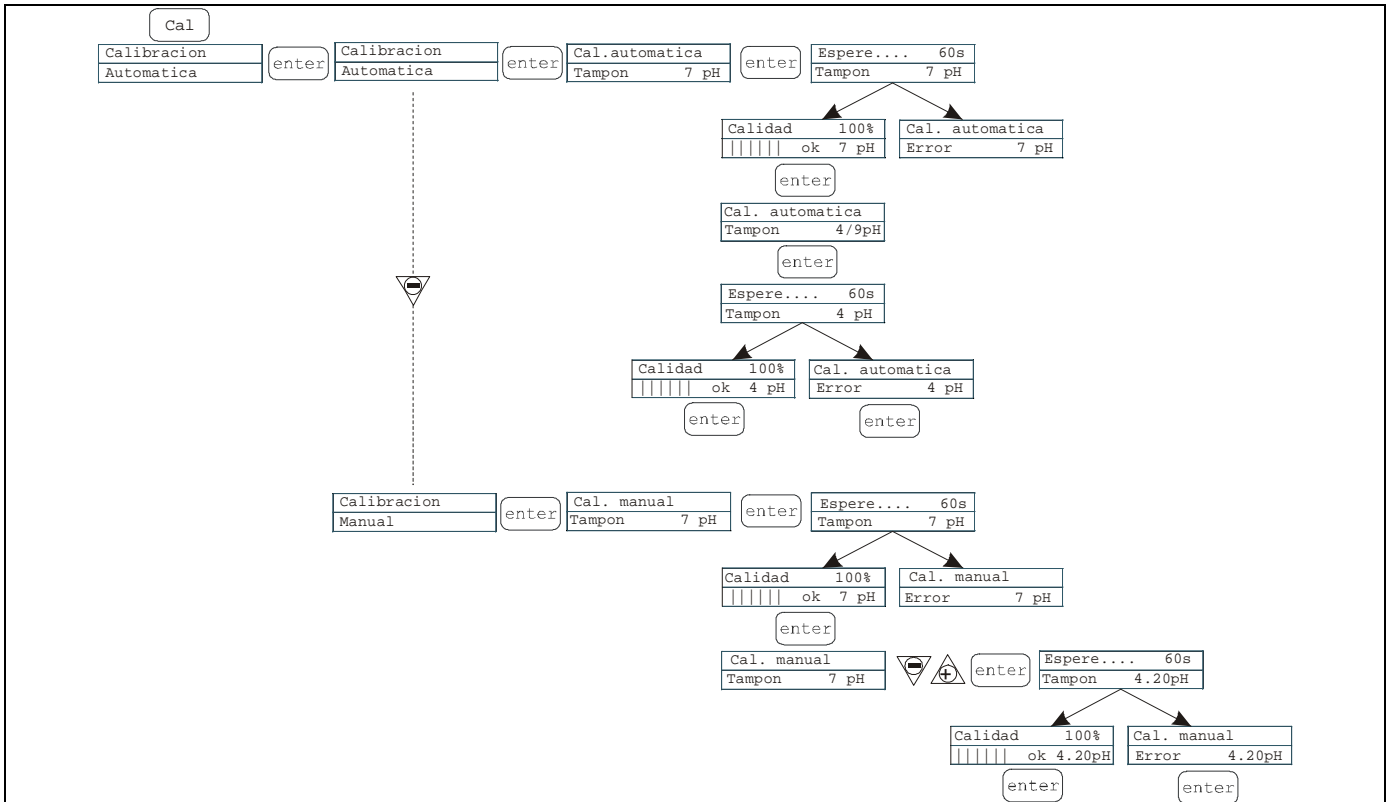

Si la calibración está activa:







Es posible elegir el modo automático o manual, en ambos casos la calibración con pH 7 se lleva a cabo automáticamente.

- Calibración automática:

En el display aparece el valor de la solución tampón, introducir la sonda en el frasco, pulsando la tecla  en el display aparece el conteo al revés de los 60 segundos necesarios para completar la calibración. Si la cantidad de la alineación fuera inferior al 50%, en el display aparece un error, pulsando la tecla  se sale de la calibración (después de 4 segundos la bomba sale automáticamente), si la cantidad fuera superior al 50% el valor se visualiza en el display y pulsando la tecla  se solicita la solución tampón con pH 4 ó 9; ahora el procedimiento es igual al anterior.

- Calibración manual:

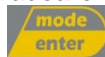
Cuando en el display aparece el valor de la solución tampón, introducir la sonda en el frasco, pulsando la tecla  en el display aparece el conteo al revés de los 60 segundos necesarios para completar la calibración. Si la cantidad de la alineación fuera inferior al 50% en el display aparece un error, pulsando la tecla  se sale de la calibración (después de 4 segundos la bomba sale automáticamente), si la cantidad fuera superior al 50% el valor se visualiza en el display y pulsando la tecla  en el display parpadea el valor de pH 7.00, con las teclas   se introduce el valor de la solución que se posee; con la tecla  se confirma y se pone en marcha el procedimiento de calibración como anteriormente.



## Menú calibración Potencial Redox (O.R.P.)

Pulsando la tecla CAL por tres segundos se entra en el menú calibración, si en programación la calibración ha sido excluida, en el display aparece:

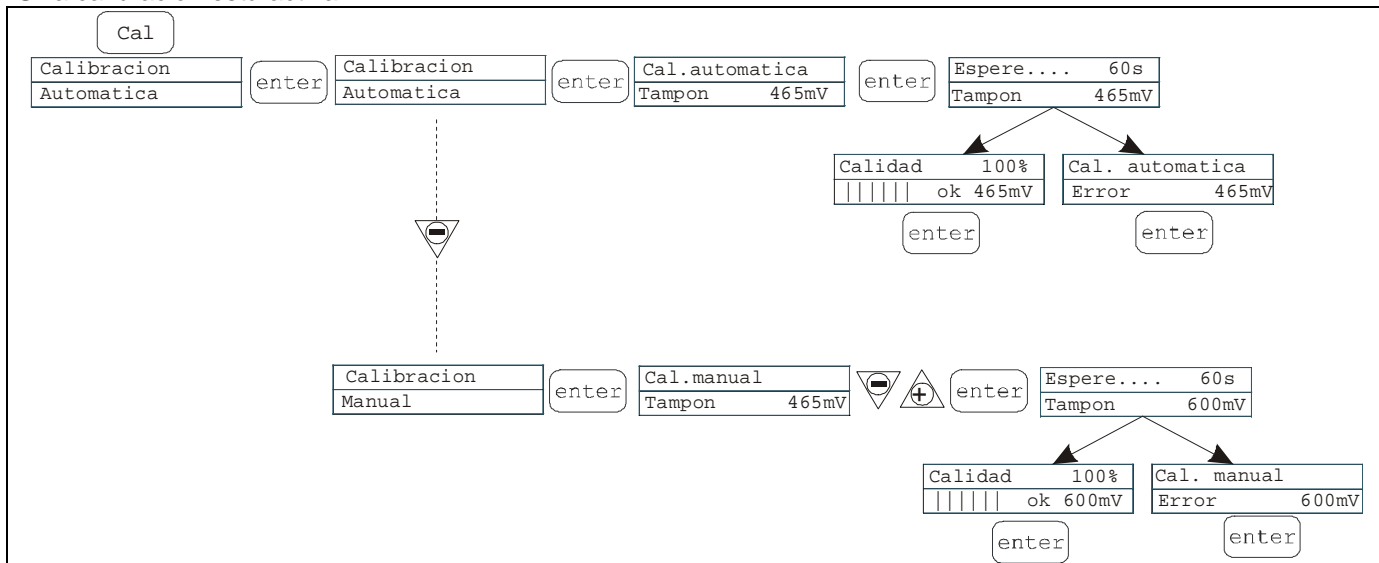

Calibration
Off

Si la calibración está activa:







Es posible elegir el modo automático o manual.



- Calibración automática:

En el display aparece el valor de la solución tampón, introducir la sonda en el frasco, pulsando la tecla  en el display aparece el conteo al revés de los 60 segundos necesarios para completar la calibración. Si la cantidad de la alineación fuera inferior al 50% en el display aparece un error, pulsando la tecla  se sale de la calibración (después de 4 segundos la bomba sale automáticamente), si la cantidad fuera superior al 50% el valor se visualiza en el display y pulsando la tecla  se termina el procedimiento.

- Calibración manual:

En el display aparece el valor de la solución tampón, introducir la sonda en el frasco, pulsando la tecla  en el display parpadea el valor de 465 mV; introducir la sonda en la solución, después con las teclas   visualizar el valor de la solución, con la tecla  confirmar y poner en marcha el procedimiento de calibración como anteriormente.

## Alarmas

Visualización	Causa	Interrupción				
Led Alarma fijo Mensaje Lev parpadeante Ej: <table border="1" style="display: inline-table; vertical-align: middle;"> <tr> <td>Man</td> <td></td> </tr> <tr> <td>Lev</td> <td>P100%</td> </tr> </table>	Man		Lev	P100%	Alarma de final del nivel sin interrupción del funcionamiento de la bomba.	Reestablecer el nivel del líquido.
Man						
Lev	P100%					
Led Alarma fijo Mensajes Lev y Stop parpadeantes Ej: <table border="1" style="display: inline-table; vertical-align: middle;"> <tr> <td>Man</td> <td></td> </tr> <tr> <td>Lev Stop</td> <td>P100%</td> </tr> </table>	Man		Lev Stop	P100%	Alarma de final del nivel con interrupción del funcionamiento de la bomba.	Reestablecer el nivel del líquido.
Man						
Lev Stop	P100%					
Led Alarma fijo Mensaje Flw parpadeante Ej: <table border="1" style="display: inline-table; vertical-align: middle;"> <tr> <td>Man</td> <td><u>E</u></td> </tr> <tr> <td>Flw</td> <td>P100%</td> </tr> </table>	Man	<u>E</u>	Flw	P100%	Alarma de flujo activa, la bomba no ha recibido el número de señales programadas por el sensor de flujo.	Pulsar la tecla 
Man	<u>E</u>					
Flw	P100%					
Ej: <table border="1" style="display: inline-table; vertical-align: middle;"> <tr> <td>Parameter Error</td> <td></td> </tr> <tr> <td>PROG to default</td> <td></td> </tr> </table>	Parameter Error		PROG to default		Error de comunicación con la eeprom.	Pulsar la tecla  para reestablecer los parámetros de <i>default</i> .
Parameter Error						
PROG to default						
Mensaje "OFA" parpadeante Mensaje "Stop" parpadeante Ej: <table border="1" style="display: inline-table; vertical-align: middle;"> <tr> <td>High</td> <td>475 mV OFA</td> </tr> <tr> <td>Stop</td> <td>P 75%</td> </tr> </table>	High	475 mV OFA	Stop	P 75%	Alarma O.F.A.	Pulsar la tecla  para bloquear el parpadeo del mensaje Stop, pulsar otra vez la tecla para volver a poner en marcha la bomba.
High	475 mV OFA					
Stop	P 75%					
Mensaje "Alm" parpadeante Ej: <table border="1" style="display: inline-table; vertical-align: middle;"> <tr> <td>High</td> <td>475 mV Alm</td> </tr> <tr> <td>P</td> <td>75%</td> </tr> </table>	High	475 mV Alm	P	75%	El valor leído por la sonda está fuera del <i>range</i> de la banda de alarma programada.	Controlar que el parámetro "Banda Alarma" esté programado correctamente en programación.
High	475 mV Alm					
P	75%					
Mensaje "Cal" parpadeante Ej: <table border="1" style="display: inline-table; vertical-align: middle;"> <tr> <td>High</td> <td>475 mV Cal</td> </tr> <tr> <td>P</td> <td>75%</td> </tr> </table>	High	475 mV Cal	P	75%	Alarma de la sonda no calibrada.	Realizar el procedimiento de calibración de la sonda.
High	475 mV Cal					
P	75%					



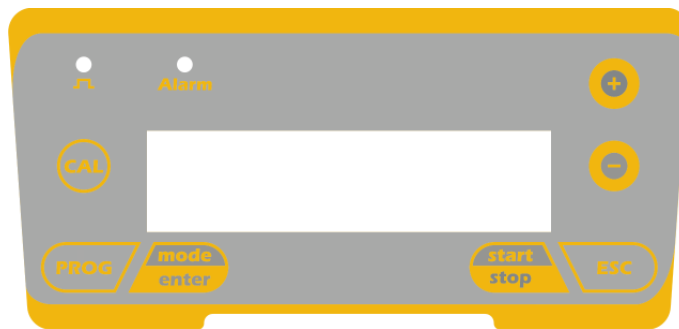

## Panneau de contrôle – ATHENA AT. PR



	Accès au menu de programmation
	Pendant la phase de fonctionnement de la pompe: si cette touche est enfoncée elle affiche à des intervalles réguliers les valeurs programmées; si elle est enfoncée en même temps que les touches   elle augmente ou réduit une valeur dépendant du mode de fonctionnement choisi. Au cours de la programmation, elle fait fonction de "enter", c'est-à-dire qu'elle confirme l'entrée dans les différents niveaux de menu et les modifications à l'intérieur de ces derniers.
	Fait démarrer et met à l'arrêt la pompe. Dans les conditions d'alarme de niveau (unique fonction d'alarme), de flux et de mémoires actives, elle désactive la signalisation sur l'afficheur.
	Pour "quitter" ces différents niveaux de menu. Avant de quitter définitivement la programmation, on accède à la demande d'enregistrement des modifications
	Menu de calibrage.
	Fait défiler les menus vers le haut ou augmente les valeurs numériques à modifier. En mode de fonctionnement Batch, elle peut faire démarrer le dosage.
	Fait défiler les menus vers le bas, ou réduit les valeurs numériques à modifier.
	Led verte clignotante pendant le dosage.
	Led rouge qui s'allume dans les différentes situations d'alarme.

### Connexions électriques

	1	Relais Alarme	
	2		
	3	Pole +	Entrée signal 4-20 mA
	4	Pole -	
	5	Entrée commande à distance (start-stop)	
	6		
	7	Entrée sonde de température	
	8		
	9	Entrée capteur de débit	
	10		
B	Entrée sonde de niveau		

Appuyer sur la touche  pendant plus de trois secondes pour allumer la programmation. Avec les touches   il est possible de faire défiler les options du menu, la touche  permet d'accéder aux modifications.

La pompe est programmée en usine en mode constant. La pompe reprend automatiquement le mode de fonctionnement après 1 minute de non-activité. Dans ce cas, les données éventuellement introduites ne sont pas enregistrées. La touche  permet de quitter les niveaux de la programmation. À la sortie de la programmation, l'afficheur visualise:

Exit
No Save

▽ ▲

Exit
Save



Pour confirmer le choix

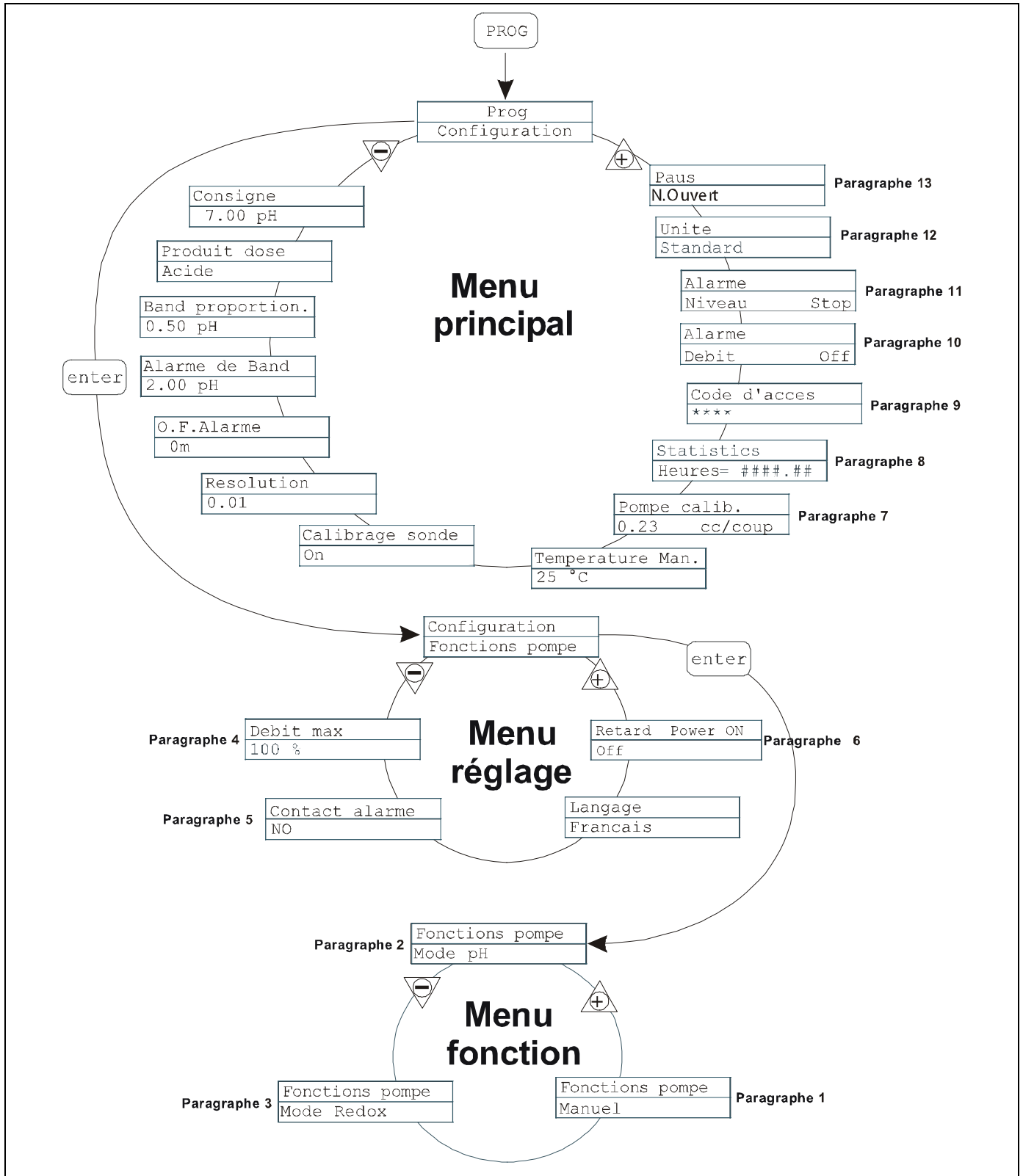

## Programmation de la langue

Programmation	Fonctionnement
<pre> graph TD     A[PROG] --&gt; B[PROG Configuration]     B --&gt; C[enter]     C --&gt; D[Configuration Pump Functions]     D --&gt; E[Max flow rate P100%]     E --&gt; F[Alarm Relay N.Open]     F --&gt; G[Language English]     G --&gt; H[enter]     H --&gt; I[+]     I --&gt; J[enter]     J --&gt; K[ ]     </pre>	<p>Permet de sélectionner la langue, la pompe est programmée en usine en anglais.</p> <p>Appuyer sur  pour accéder à la modification, puis sur les touches   pour programmer la valeur. La touche  confirme et permet de retourner au menu principal.</p>

## Paragraphe 1 – Dosage manuel

Programmation	Fonctionnement
<pre> graph TD     A[PROG] --&gt; B[PROG Configuration]     B --&gt; C[enter]     C --&gt; D[Configuration Fonctions pompe]     D --&gt; E[enter]     E --&gt; F[+]     F --&gt; G[Fonctions pompe Manuel &lt;-]     G --&gt; H[enter]     </pre>	<p>La pompe travaille en mode constant. Le débit est réglé manuellement en appuyant simultanément sur les touches   pour augmenter le débit. ou sur les touches   pour le réduire.</p>





Affichage pendant le fonctionnement	Affichage lors de la programmation (touche MODE)
<pre> graph TD     A[Mode de fonctionnement • Man = Manuelle] --&gt; C[MAN F Niv Stop P100%]     B[État capteur de FLUX] --&gt; C     D[Valeur du dosage en cours (dépend de l'unité de mesure sélectionnée) • Pourcentage, Fréquence, l/h, Gph, ml/m] --&gt; C     E[État de la pompe • Vide=pompe au démarrage • Stop = pompe arrêtée • Paus = pompe en pause] --&gt; C     F[Alarmes et états • Niv = Alarme niveau • Deb = Alarme flux] --&gt; C     </pre>	<pre> graph TD     A[Mode de fonctionnement • Affiche la valeur correspondante de la fréquence] --&gt; B[F320s/m P100%]     C[Valeur du dosage en cours • Modification du débit maximal en appuyant en même temps sur + ou -] --&gt; B     </pre>

Paragraphe 2 – Dosage proportionnel à la mesure du pH (programmation d'usine)

Programmation	Fonctionnement
<pre> PROG ----- PROG Configuration ----- enter ----- Configuration Fonctions pompe ----- enter ----- Fonctions pompe Manuel ----- enter ----- Consigne 7.00 pH ----- enter ----- Produit dose Acide ----- enter ----- Band proportion. 0.50 pH ----- enter ----- Alarme de Band 2.00 pH ----- enter ----- O.F.Alarme 0m ----- enter ----- Resolution 0.01 ----- enter ----- Calibrage sonde On ----- enter ----- Temperature Man. 25 °C ----- enter ----- Temperature Man. 25 °C ----- enter ----- Temperature Man. 77 °F ----- enter </pre>	<p>La pompe mesure et contrôle la valeur de pH d'une solution, en programmant dans l'ordre : point de consigne, type de point de consigne, bande proportionnelle et bande d'alarme.</p> <p>Type point de consigne : acide</p> <p>Type point de consigne : alcalin</p> <p>Il est en outre possible de programmer :</p> <ul style="list-style-type: none"> <li>- Le temps O.F.A. (Over Feed Alarm) en minutes soit un temps au-delà duquel, si la mesure du pH n'arrive pas au point de consigne, un signal d'alarme se déclenche.</li> <li>- La résolution de la mesure (1 ou 2 chiffres décimaux)</li> <li>- Désactivation/activation de la procédure de calibrage</li> <li>- Valeur manuelle de la température en °C (usine) ou °F</li> </ul> <p>La fréquence maximale est modifiable pendant la phase de fonctionnement en appuyant simultanément sur les touches</p> <p> pour augmenter le débit ou sur les touches  pour le réduire.</p>

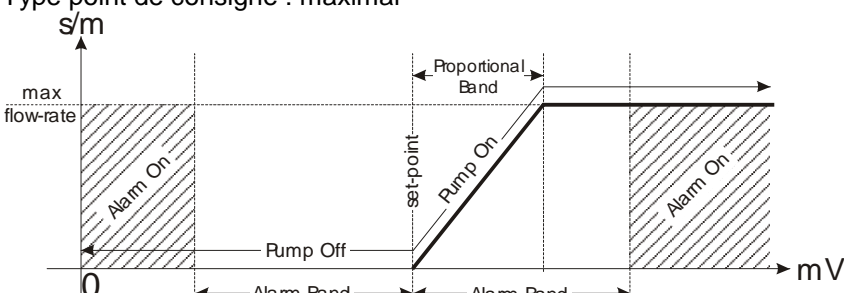
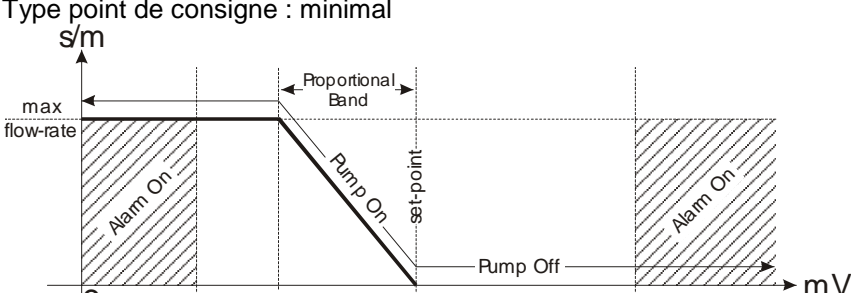
Affichage pendant le fonctionnement	Affichage lors de la programmation (touche MODE)
<div style="display: flex; justify-content: space-between;"> <div style="border: 1px solid black; padding: 5px; width: 30%;"> <p>Type P.de consigne; Acide/Alcalin</p> </div> <div style="border: 1px solid black; padding: 5px; width: 30%;"> <p>État capteur de FLUX</p> </div> <div style="border: 1px solid black; padding: 5px; width: 30%;"> <p>Valeur de mesure du pH</p> </div> </div> <div style="text-align: center; margin: 10px 0;"> <p>Alca <b>F</b> 7.00pH Niv Stop P100%</p> </div> <div style="display: flex; justify-content: space-between;"> <div style="border: 1px solid black; padding: 5px; width: 30%;"> <p><b>Alarmes et états</b></p> <ul style="list-style-type: none"> <li>• Cal = calibrage non effectué</li> <li>• Lev = Alarme niveau</li> <li>• Flw = Alarme flux</li> <li>• Alm = Mesure hors Bande alarme</li> <li>• OFA = Alarme O.F.A.</li> </ul> </div> <div style="border: 1px solid black; padding: 5px; width: 30%;"> <p><b>État de la pompe</b></p> <ul style="list-style-type: none"> <li>• Vide=pompe au démarrage</li> <li>• Stop = pompe arrêtée</li> <li>• Paus = pompe en pause</li> </ul> </div> <div style="border: 1px solid black; padding: 5px; width: 30%;"> <p><b>Valeur du dosage en cours</b> (dépend de l'unité de mesure sélectionnée)</p> <ul style="list-style-type: none"> <li>• Pourcentage, Fréquence, l/h, Gph, ml/m</li> </ul> </div> </div>	<p style="text-align: center;"><b>Affiche dans l'ordre:</b></p> <ul style="list-style-type: none"> <li>• SP = valeur Point de consigne</li> <li>• BP = valeur Bande Proportionnelle</li> <li>• BA = valeur Bande Alarme</li> <li>• OFA = Valeur O.F.A.</li> <li>• TEMP=Valeur Température</li> </ul> <div style="text-align: center; margin: 10px 0;"> <p>SP 7.00pH 4.50pH P100%</p> </div> <p style="text-align: right;">Valeur de la mesure.</p> <div style="text-align: center; margin: 10px 0;"> <p><b>Valeur du dosage maximal programmé</b> (dépend de l'unité de mesure sélectionnée)</p> <ul style="list-style-type: none"> <li>• Pourcentage, Fréquence, l/h, Gph, ml/m</li> </ul> </div>

Paragraphe 3 – Dosage proportionnel à la mesure du potentiel Redox (O.R.P.)

Programmation	Fonctionnement
<p>                     PROG                      Configuration                      enter                      Configuration                      Fonctions pompe                      enter                      Fonctions pompe                      Mode Redox                      enter                      Consigne 560 mV enter                      Dosage Haute enter                      Band proportion. 50 mV enter                      Alarme de Band 200 mV enter                      O.F.Alarme 0m enter                      Calibrage sonde On enter                      [ ]                 </p>	<p>La pompe mesure et contrôle la valeur de pH d'une solution, en programmant dans l'ordre : point de consigne, type de point de consigne, bande proportionnelle et bande d'alarme.</p> <p>Type point de consigne : maximal</p>  <p>Type point de consigne : minimal</p>  <p>Il est en outre possible de programmer :</p> <ul style="list-style-type: none"> <li>- Le temps O.F.A. (Over Feed Alarm) en minutes soit un temps au-delà duquel, si la mesure du pH n'arrive pas au point de consigne, un signal d'alarme se déclenche.</li> <li>- La résolution de la mesure (1 ou 2 chiffres décimaux)</li> <li>- Désactivation/activation de la procédure de calibrage</li> </ul> <p>La fréquence maximale est modifiable pendant la phase de fonctionnement en appuyant simultanément sur les touches  pour augmenter le débit ou sur les touches   pour le réduire.</p>

Affichage pendant le fonctionnement	Affichage lors de la programmation (touche MODE)
<p>                     • Type P. de Consigne Haut/Bas                      État capteur de FLUX                      Valeur mesure du potentiel Redox.                      Haut F 560mV                      Niv Stop P100%                      Valeur du dosage en cours (dépend de l'unité de mesure sélectionnée)                      • Pourcentage, Fréquence, l/h, Gph, ml/m                      État de la pompe                      • Vide=pompe au démarrage                      • Stop = pompe arrêtée                      • Paus = pompe en pause                      Alarmes et états                      • Cal = calibrage non effectué                      • Lev = Alarme niveau                      • Flw = Alarme flux                      • Alm = Mesure hors Bande alarme                      • OFA = Alarme O.F.A.                 </p>	<p>                     Affiche dans l'ordre                      • SP = valeur Point de consigne                      • BP = valeur Bande Proportionnelle                      • BA = valeur Bande Alarme                      • OFA = Valeur O.F.A.                      SP 560mV                      BP 450mV                      Valeur de la mesure.                      P100%                      Valeur du dosage maximal programmé (dépend de l'unité de mesure sélectionnée)                      • Pourcentage, Fréquence, l/h, Gph, ml/m                 </p>

#### Paragraphe 4 – Programmation débit maximal

Programmation	Fonctionnement
<pre> graph TD     A[PROG] --&gt; B[PROG Configuration]     B --&gt; C[enter]     C --&gt; D[Configuration Fonctions pompe]     D --&gt; E[Debit max P100%]     E --&gt; F[enter]     F --&gt; G[Debit max P100%]     G --&gt; H[enter]     H --&gt; I[Debit max F320g/m]     I --&gt; J[enter]     J --&gt; K[ ]     style K fill:none,stroke:none     </pre>	<p>Permet de programmer le débit maximal pouvant être atteint par la pompe et le mode programmé (% ou fréquence) devient l'affichage du débit dans l'unité de mesure standard. Appuyer sur  pour accéder à la modification, puis avec les touches  programmer la valeur. Avec  confirmer et retourner au menu principal.</p>

#### Paragraphe 5 – Programmation du relais d'alarme

Programmation	Fonctionnement
<pre> graph TD     A[PROG] --&gt; B[PROG Configuration]     B --&gt; C[enter]     C --&gt; D[Configuration Fonctions pompe]     D --&gt; E[Debit max P100%]     E --&gt; F[enter]     F --&gt; G[Contact alarme NO]     G --&gt; H[enter]     H --&gt; I[ ]     style I fill:none,stroke:none     </pre>	<p>Sert à programmer le relais d'alarme en l'absence d'une situation d'alarme, si ouvert (usine) ou fermé. Appuyer sur  pour accéder à la modification puis avec les touches  programmer la valeur. Avec  confirmer et retourner au menu principal.</p>

#### Paragraphe 6 – Configuration Retard Power On

Programmation	Fonctionnement
<pre> graph TD     A[PROG] --&gt; B[PROG Configuration]     B --&gt; C[enter]     C --&gt; D[Configuration Fonctions Pompe]     D --&gt; E[Debit Max P100%]     E --&gt; F[enter]     F --&gt; G[Contact alarme NO]     G --&gt; H[enter]     H --&gt; I[Langage Français]     I --&gt; J[enter]     J --&gt; K[Retard Power ON Off]     K --&gt; L[enter]     L --&gt; M[ ]     style M fill:none,stroke:none     </pre>	<p>Permet de configurer un retard du fonctionnement de la pompe lors de son allumage. Ce retard prend effet uniquement si la pompe est éteinte et rallumée en coupant l'alimentation. La configuration peut être désactivée avec Off (usine) ou alors, il est possible de configurer un retard de 1 à 60 minutes. Avec le retard actif, durant le temps configuré, les leds d'alarme et d'impulsion clignotent en même temps (1 sec On – 1 sec Off) et l'écran affiche un compte à rebours en secondes. Si la pompe est en état d'Arrêt, seules les leds clignotantes s'affichent. Durant le temps de retard la fonction peut être désactivée en accédant au menu et en configurant le temps sur Off. En appuyant sur  l'on accède à la modification, ensuite avec les touches  l'on configure la valeur. Avec  l'on confirme et retourne au menu principal.</p>

#### Paragraphe 7 – Calibrage débit

Programmation	Fonctionnement
<pre> graph TD     A[PROG] --&gt; B[PROG Configuration]     B --&gt; C[ ]     style C fill:none,stroke:none     C --&gt; D[Calib. pompe 0,23 cc/coup]     D --&gt; E[enter]     E --&gt; F[Calib. pompe Manual]     F --&gt; G[enter]     G --&gt; H[Calibrage Auto Start 100 coups]     H --&gt; I[enter]     I --&gt; J[Calibrage Auto Coups 100]     J --&gt; K[ ]     style K fill:none,stroke:none     K --&gt; L[Calibrage Auto ml 20]     L --&gt; M[enter]     M --&gt; N[ ]     style N fill:none,stroke:none     </pre>	<p>Le menu principal affiche la valeur de cc par coup en mémoire. Il est possible de calibrer en deux modes :  <b>MANUEL</b> – insérer manuellement la valeur en cc par coup avec les touches  et confirmer avec   <b>AUTOMATIQUE</b> – la pompe exécute 100 coups qui sont activés avec la touche , une fois terminés, insérer la quantité aspirée par la pompe avec les touches  et confirmer avec .          La donnée insérée sera utilisée dans les calculs des débits</p>



Paragraphe 8 – Statistiques

Programmation	Fonctionnement
	<p>Le menu principal affiche les heures de fonctionnement de la pompe, appuyer sur  pour accéder aux autres statistiques.</p> <ul style="list-style-type: none"> <li>- Strokes = nombre de coups exécutés par la pompe</li> <li>- Q.ty(L) = quantité dosée par la pompe exprimée en litres; cette donnée est calculée d'après la valeur cc/stroke en mémoire</li> <li>- Power = nombre de démarrages de la pompe</li> <li>- Reset = les touches  permettent de réinitialiser les compteurs (YES) ou non (NO), appuyer sur  pour confirmer.</li> </ul> <p>La pression de  permet de retourner au menu principal.</p>

Paragraphe 9 – Password

Programmation	Fonctionnement
	<p>Entrer le mot de passe pour entrer dans la programmation et voir toutes les valeurs programmées, le mot de passe sera demandé à chaque tentative de modification</p> <p>La ligne clignotante indique le nombre modifiable, avec la touche  sélectionner le nombre (de 1 à 9), avec la touche  sélectionner le nombre à modifier puis avec la touche  confirmer. En programmant "0000" (défaut), le mot de passe est exclu.</p>

Paragraphe 10 – Alarme de flux

Programmation	Fonctionnement
	<p>Permet d'activer (Désactiver) le capteur de flux.</p> <p>Une fois activé (On) appuyer sur la touche  pour accéder à la demande de combien de signaux la pompe attend avant de déclencher l'état d'alarme. En appuyant sur  le nombre clignote, puis avec les touches  programmer la valeur. Avec  confirmer. Appuyer sur  pour retourner au menu principal</p>

Paragraphe 11 – Alarme de niveau

Programmation	Fonctionnement
	<p>Permet de programmer la pompe lorsque l’alarme du capteur de niveau s’active, à savoir si bloquer le dosage (Stop) ou si tout simplement activer la signalisation d’alarme sans bloquer le dosage.</p> <p>Appuyer sur  pour accéder à la modification. Puis avec les touches   programmer le type d’alarme.</p> <p>Avec  confirmer. Appuyer sur  pour retourner au menu principal.</p>

Paragraphe 12 – Unité Affichage débit

Programmation	Fonctionnement
	<p>Permet de programmer l’unité de mesure du dosage sur l’afficheur.</p> <p>Appuyer sur  pour accéder à la modification, puis appuyer sur   pour programmer le type d’unité de mesure, L/h (Litres/heure), Gph (Gallons/heure), ml/m (millilitres/minute) ou standard (% ou fréquence selon la programmation), Appuyer sur  pour confirmer et retourner au menu principal</p>

Paragraphe 13 – Programmation Pause

Programmation	Fonctionnement
	<p>Entrée signal pour mettre la pompe en pause. Le système est réglé d’usine en Normalement Ouvert.</p> <p>Appuyer sur  pour accéder à la modification puis avec les touches   programmer la valeur (N. OUVERT ou N. FERME’).</p> <p>Avec  confirmer et retourner au menu principal.</p>

## Menu Calibrage pH

Appuyer sur la touche CAL x 3 secondes pour entrer dans le menu calibrage, si lors de la programmation, le calibrage a été exclu, l'afficheur visualise :

Calibrage
Off

Si le calibrage est actif :

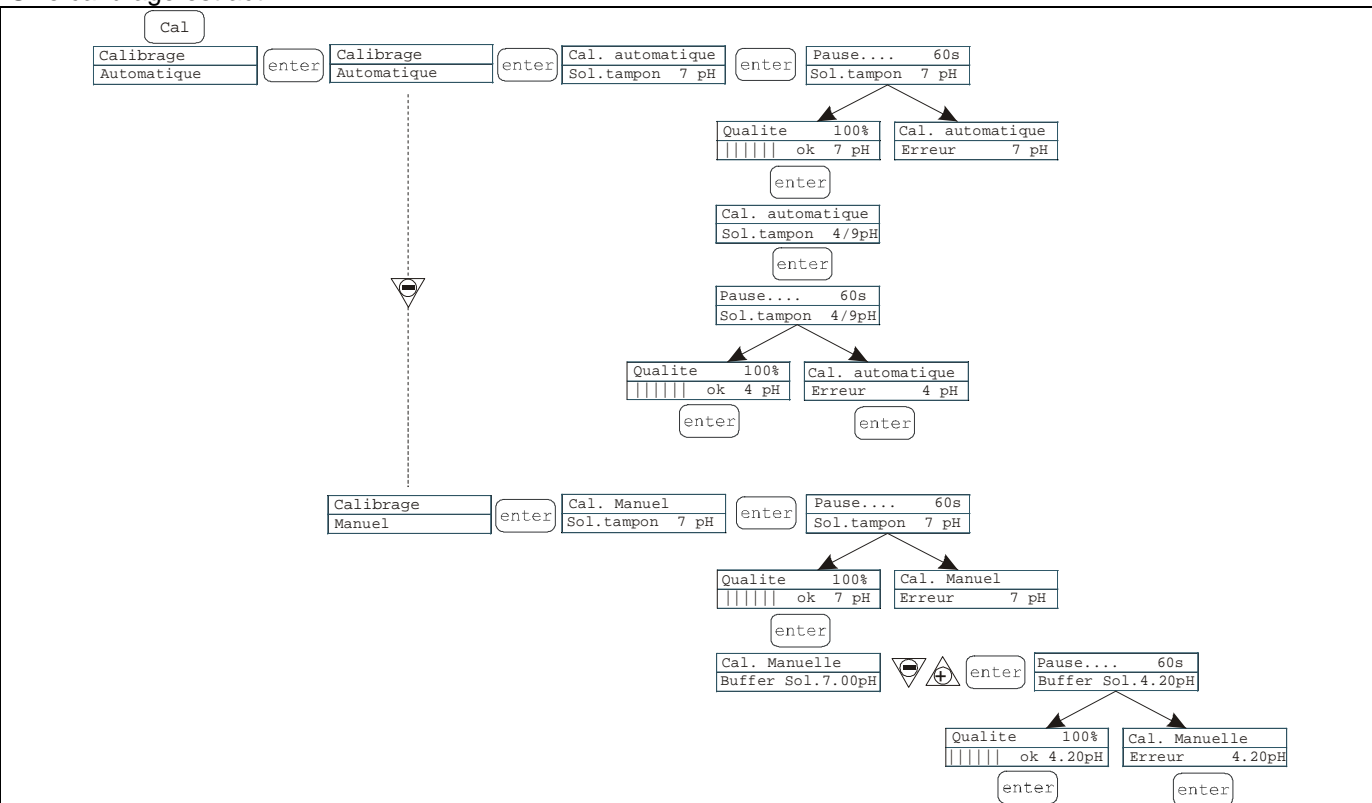

Il est possible de choisir le mode automatique ou manuel, dans les deux cas le calibrage à pH 7 se fait automatiquement.

- Calibrage automatique :

L'afficheur visualise la valeur de la solution tampon, insérer la sonde dans le flacon, appuyer sur  pour que le compte à rebours des 60 secondes nécessaires pour compléter le calibrage s'affiche.

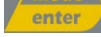
Si la qualité de l'alignement est inférieure à 50% l'erreur s'affiche et appuyer sur  pour quitter le calibrage (après 4 secondes la pompe sort automatiquement), si la qualité est supérieure à 50%, la valeur s'affiche et en

appuyant sur  on obtient la demande de la solution tampon à pH 4 ou 9 ; à ce point la procédure est la même que la précédente,

- Calibrage manuel :

lorsque sur l'afficheur visualise la valeur de la solution tampon, insérer la sonde dans le flacon, appuyer sur  pour que le compte à rebours des 60 secondes nécessaires pour compléter le calibrage s'affiche.

Si la qualité de l'alignement est inférieure à 50% l'erreur s'affiche et appuyer sur  pour quitter le calibrage (après 4 secondes la pompe sort automatiquement), si la qualité est supérieure à 50%, la valeur s'affiche et en

appuyant sur  on obtient le clignotement de la valeur de pH 7.00, avec les touches   introduire la valeur de la solution possédée puis appuyer sur  pour confirmer et faire démarrer la procédure de calibrage comme auparavant.

## Menu Calibrage Potentiel Redox (O.R.P.)

Appuyer sur la touche CAL x 3 secondes pour entrer dans le menu de calibrage, si lors de la programmation, le calibrage a été exclu, l'afficheur visualise:

Calibrage
Off

Si le calibrage est actif:

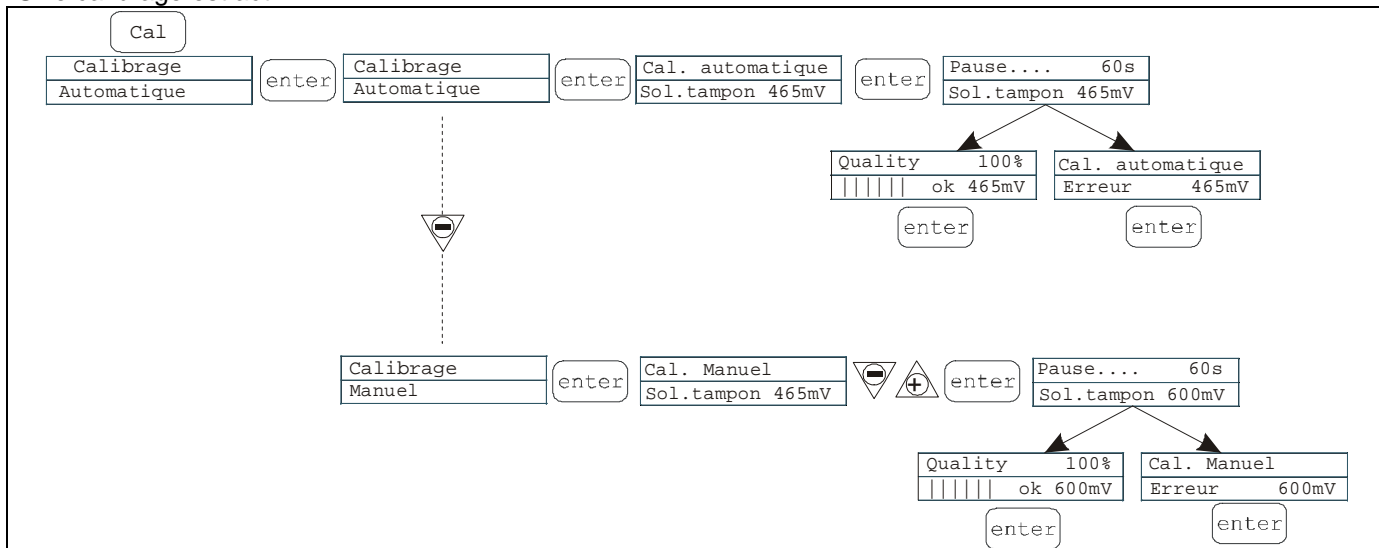



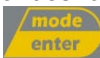

Il est possible de choisir le mode automatique ou manuel.

- Calibrage automatique:



La valeur de la solution tampon s'affiche, insérer la sonde dans le flacon, appuyer sur  pour que le compte à rebours des 60 secondes nécessaires pour compléter le calibrage s'affiche.

Si la qualité de l'alignement est inférieure à 50% l'erreur s'affiche et appuyer sur  pour quitter le calibrage (après 4 secondes la pompe sort automatiquement), si la qualité est supérieure à 50%, la valeur est affichée et appuyer sur  pour compléter la procédure.

- Calibrage manuel:

la valeur de la solution tampon s'affiche, insérer la sonde dans le flacon, en appuyant sur  on obtient le clignotement sur l'afficheur de la valeur de 465mV, insérer la sonde dans la solution puis appuyer sur les touches   pour visualiser la valeur de la solution possédée puis appuyer sur  pour confirmer et faire démarrer la procédure de calibrage comme auparavant.









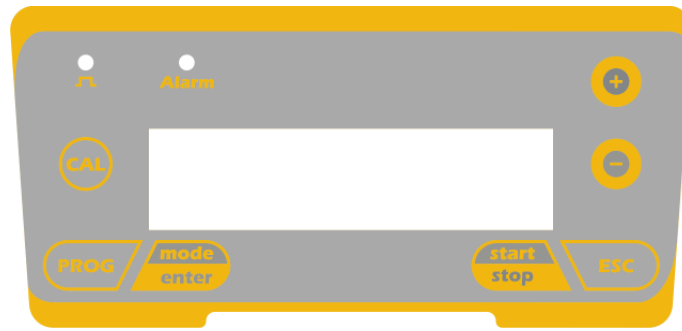

## Alarmes

Affichage	Causa	Interruption				
Led Alarme fixe Message Lev clignotant Ex: <table border="1" style="display: inline-table; vertical-align: middle;"> <tr> <td>Man</td> <td></td> </tr> <tr> <td>Lev</td> <td>P100%</td> </tr> </table>	Man		Lev	P100%	Alarme fin de niveau, sans interruption du fonctionnement de la pompe.	Rétablissement du niveau du liquide.
Man						
Lev	P100%					
Led Alarme fixe Message Lev et Stop clignotant Ex: <table border="1" style="display: inline-table; vertical-align: middle;"> <tr> <td>Man</td> <td></td> </tr> <tr> <td>Lev Stop</td> <td>P100%</td> </tr> </table>	Man		Lev Stop	P100%	Alarme fin de niveau, avec interruption du fonctionnement de la pompe.	Rétablissement du niveau du liquide.
Man						
Lev Stop	P100%					
Led Alarme fixe Message Flw clignotant Ex: <table border="1" style="display: inline-table; vertical-align: middle;"> <tr> <td>Man</td> <td><b>E</b></td> </tr> <tr> <td>Flw</td> <td>P100%</td> </tr> </table>	Man	<b>E</b>	Flw	P100%	Alarme de flux actif, la pompe n'a pas reçu le nombre de signaux programmés par le capteur de flux.	Pression de la touche 
Man	<b>E</b>					
Flw	P100%					
Ex: <table border="1" style="display: inline-table; vertical-align: middle;"> <tr> <td>Parameter Error</td> </tr> <tr> <td>PROG to default</td> </tr> </table>	Parameter Error	PROG to default	Erreur de communication avec la Eeprom.	Pression de la touche  pour rétablir les paramètres de défaut.		
Parameter Error						
PROG to default						
Message "OFA" clignotant Message "Stop" clignotant Ex: <table border="1" style="display: inline-table; vertical-align: middle;"> <tr> <td>High</td> <td>475 mV OFA</td> </tr> <tr> <td>Stop</td> <td>P 75%</td> </tr> </table>	High	475 mV OFA	Stop	P 75%	Alarme O.F.A.	Pression de la touche  pour bloquer le clignotement du message Stop, une pression supplémentaire de la touche fait redémarrer la pompe.
High	475 mV OFA					
Stop	P 75%					
Message "Alm" clignotant Ex: <table border="1" style="display: inline-table; vertical-align: middle;"> <tr> <td>High</td> <td>475 mV Alm</td> </tr> <tr> <td>P</td> <td>75%</td> </tr> </table>	High	475 mV Alm	P	75%	La valeur lue par la sonde est hors de la plage de la bande d'alarme programmée.	Contrôler la programmation correcte du paramètre "Bande Alarme" en programmation.
High	475 mV Alm					
P	75%					
Message "Cal" alarme Ex: <table border="1" style="display: inline-table; vertical-align: middle;"> <tr> <td>High</td> <td>475 mV Cal</td> </tr> <tr> <td>P</td> <td>75%</td> </tr> </table>	High	475 mV Cal	P	75%	Alarme sonde non calibrée.	Effectuer la procédure de calibrage de la sonde.
High	475 mV Cal					
P	75%					

## ATHENA AT. PR

### Pannello di controllo





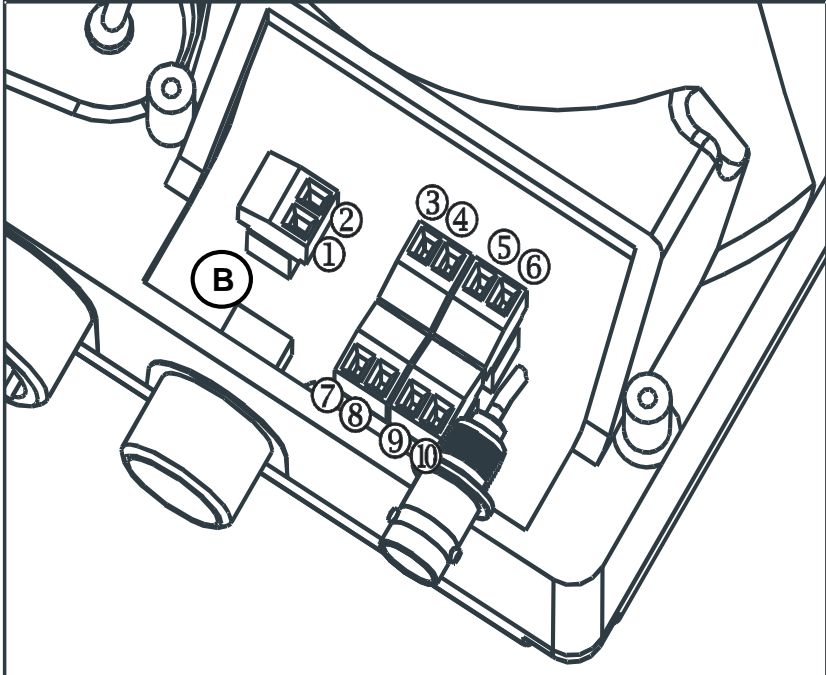

	Accesso al menu di programmazione
	Durante la fase di funzionamento della pompa: premuto visualizza ciclicamente sul display i valori programmati; Premuto contemporaneamente ai pulsanti   aumenta o decrementa un valore dipendente dalla modalità di funzionamento prescelta. In programmazione svolge la funzione "enter", cioè conferma l'ingresso nei vari livelli di menu e le modifiche all'interno degli stessi.
	Avvia e mette in fase di stop la pompa. Nelle condizioni di allarme di livello (sola funzione allarme), di flusso e memory attive, disattiva la segnalazione sul display.
	Per "uscire" dai vari livelli di menu. Prima di uscire definitivamente dalla programmazione si accede a richiesta di salvataggio delle modifiche.
	Accesso al menu di calibrazione della pompa. Se in modalità Off, il menu di calibrazione non viene attivato.
	Scorre i menu verso l'alto, oppure incrementa i valori numerici da modificare. Nella modalità Batch può avviare il dosaggio
	Scorre i menu verso il basso, oppure decrementa i valori numerici da modificare.
	Led verde lampeggiante durante il dosaggio
	Led rosso che si accende nelle varie situazioni d'allarme

#### Collegamenti elettrici

	1	Relè d'allarme	
	2		
	3	Polo +	Uscita 4-20 mA
	4	Polo -	
	5	Ingresso controllo remoto (start-stop)	
	6		
	7	Ingresso sonda di temperatura	
	8		
	9	Ingresso sensore di flusso	
	10		
B	Ingresso sonda controllo livello		

## Menu di Programmazione Athena AT. PR

Premendo il tasto  per più di tre secondi si accede alla programmazione. Con i tasti   potrete scorrere le voci del menu, con il pulsante  si accede alle modifiche. Di fabbrica la pompa è programmata in modalità costante. La pompa torna automaticamente nella modalità di funzionamento dopo 1 minuto di non attività. In questo caso dati eventualmente inseriti non vengono salvati.

Con il pulsante  si esce dai livelli della programmazione. All'uscita dalla programmazione il display visualizza:

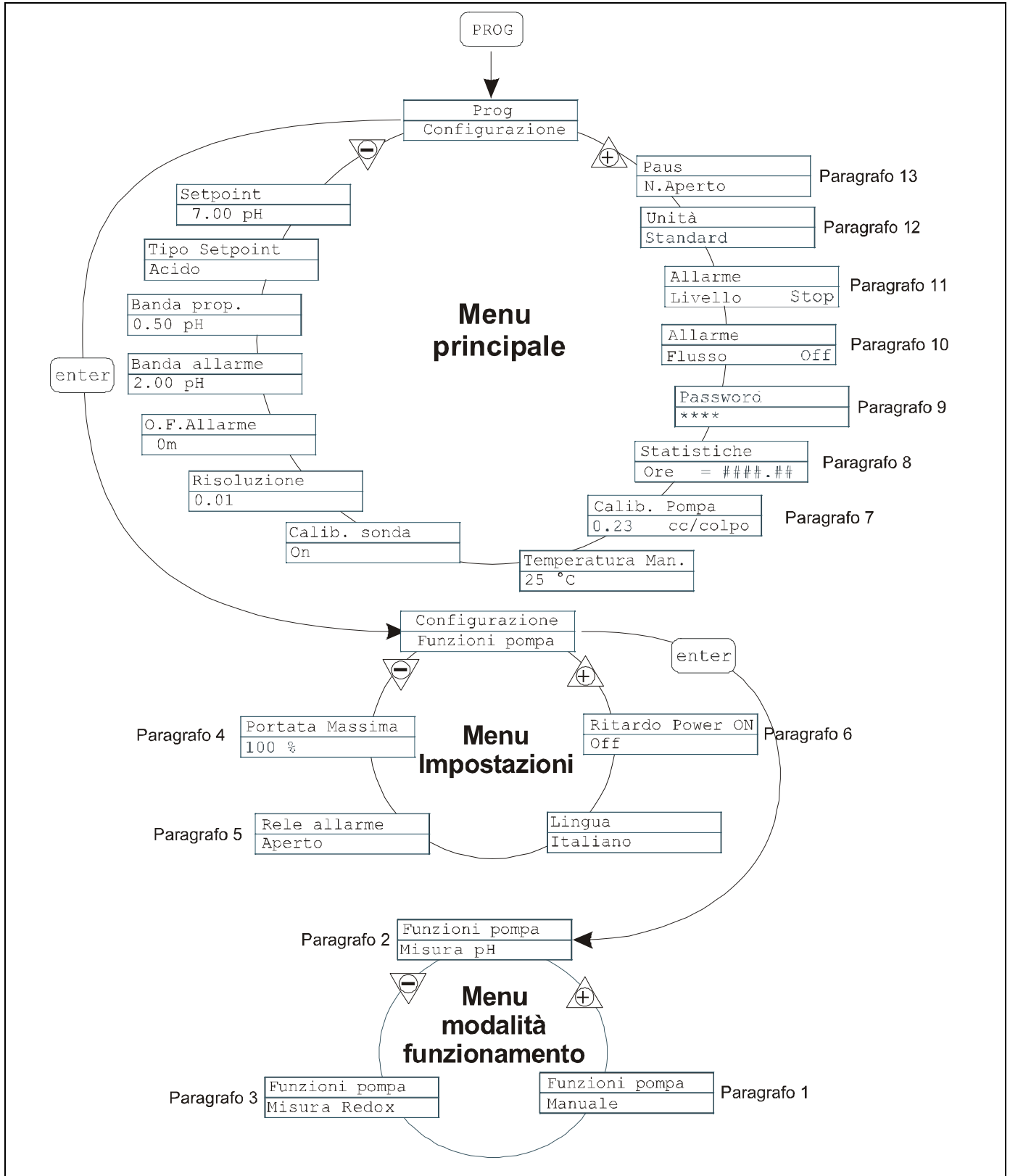
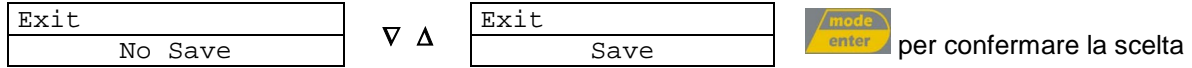

Impostazione lingua

Programmazione	Funzionamento
	<p>Permette di selezionare la lingua, di fabbrica la pompa è impostata in inglese.</p> <p>Premendo  si accede alla modifica, quindi con i tasti   imposto il valore. Con  confermo e torno al menu principale</p>

Paragrafo 1 – Dosaggio Proporzionale alla misura del pH (impostazione di fabbrica)

Programmazione	Funzionamento
	<p>La pompa misura e controlla il valore di pH di una soluzione, programmando in sequenza: set-point, tipo di set-point, banda proporzionale e banda d'allarme.</p> <p>Tipo set-point: acido</p> <p>Tipo set-point: alcalino</p> <p>Si può inoltre programmare:</p> <ul style="list-style-type: none"> <li>- il tempo O.F.A. (Over Feed Alarm) in minuti, cioè un tempo oltre il quale se la misura del pH non arriva al setpoint, si attiva un segnale d'allarme.</li> <li>- La risoluzione della misura (1 o 2 cifre decimali)</li> <li>- Disattivazione/attivazione della procedura di calibrazione</li> <li>- Valore manuale della temperatura in °C (fabbrica) o °F</li> </ul> <p>La frequenza massima è modificabile durante la fase di funzionamento premendo contemporaneamente i tasti   per aumentare la portata, oppure i pulsanti   per diminuirla.</p>



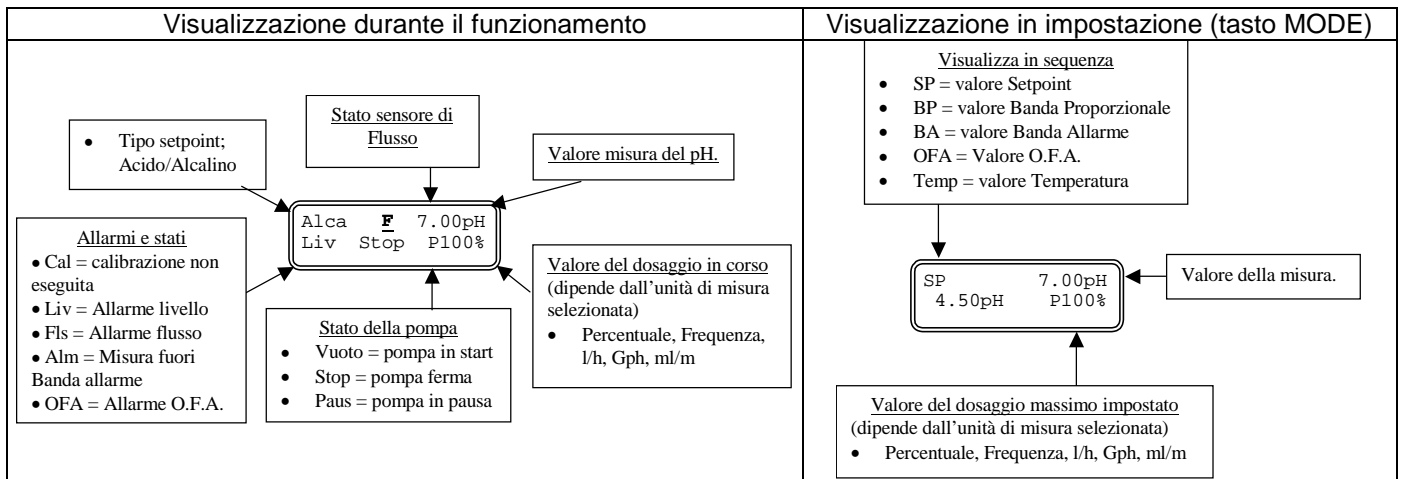

**Paragrafo 2 – Dosaggio Proporzionale alla misura del potenziale Redox (O.R.P.)**

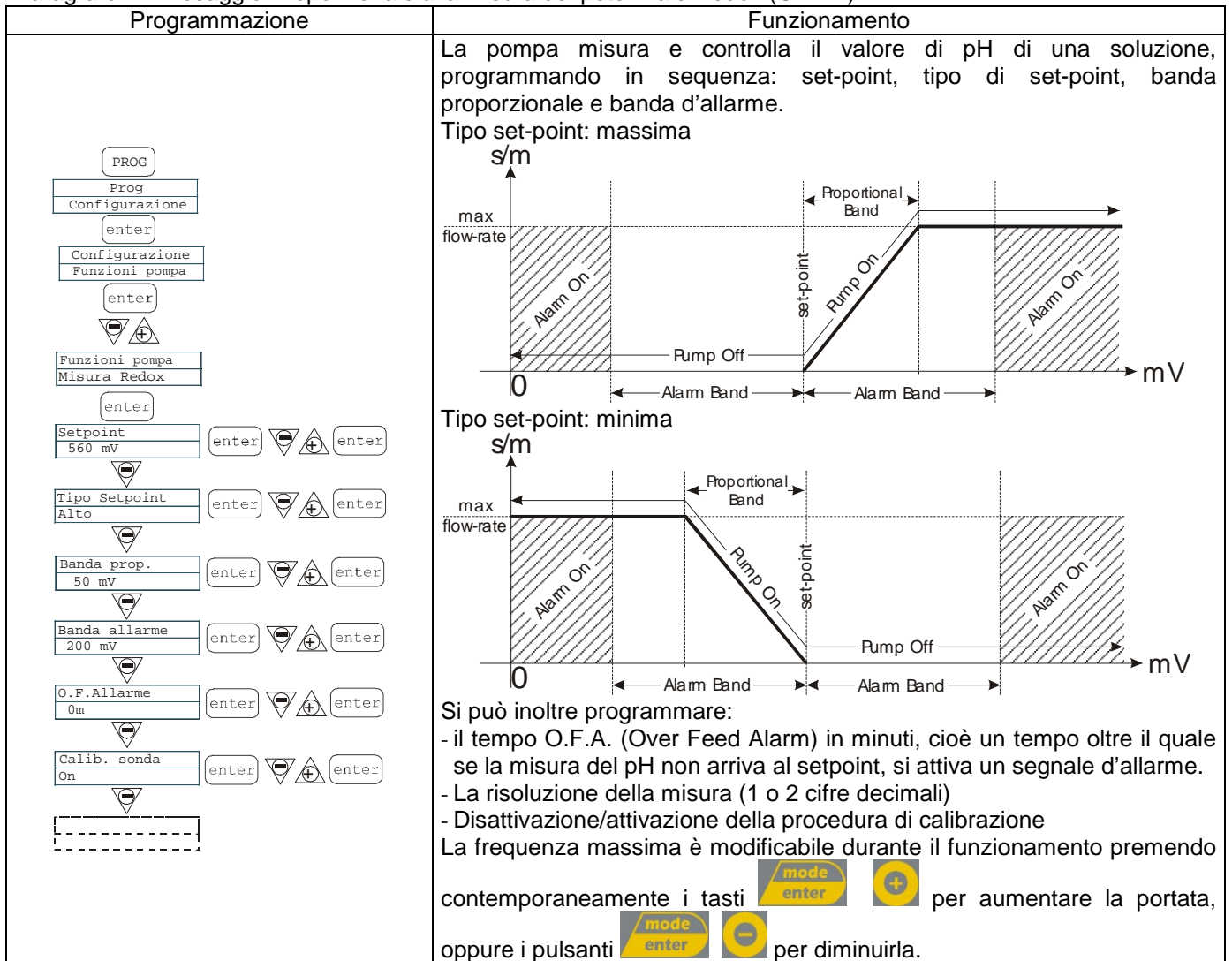

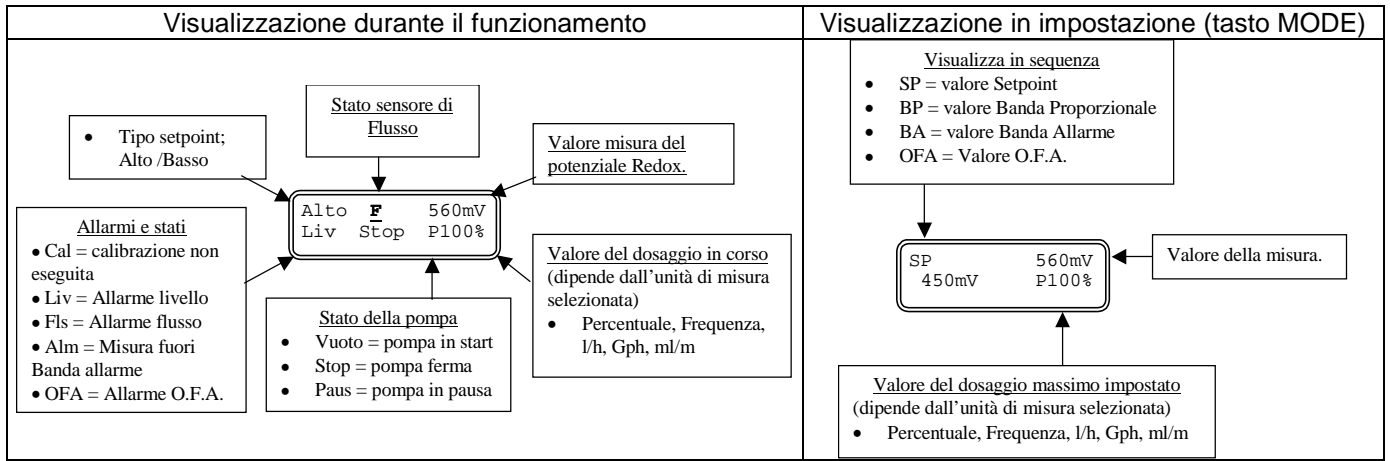

### Paragrafo 3 – Dosaggio manuale

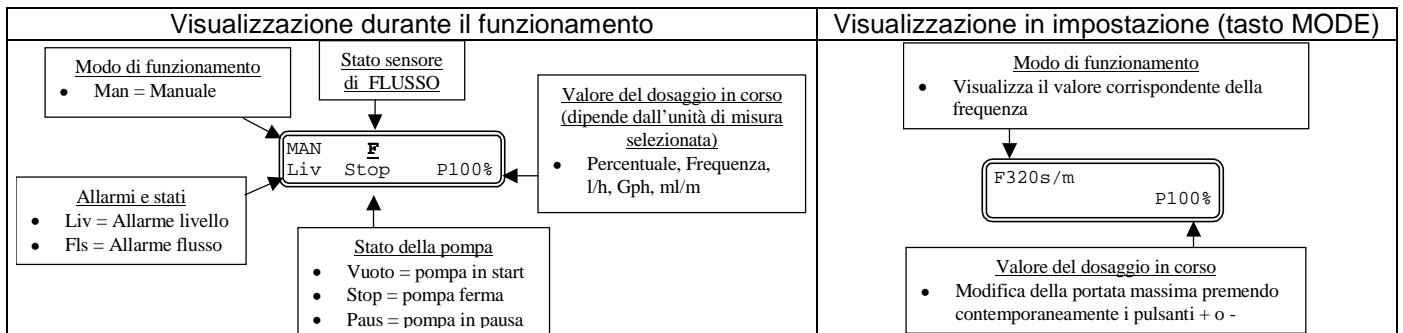
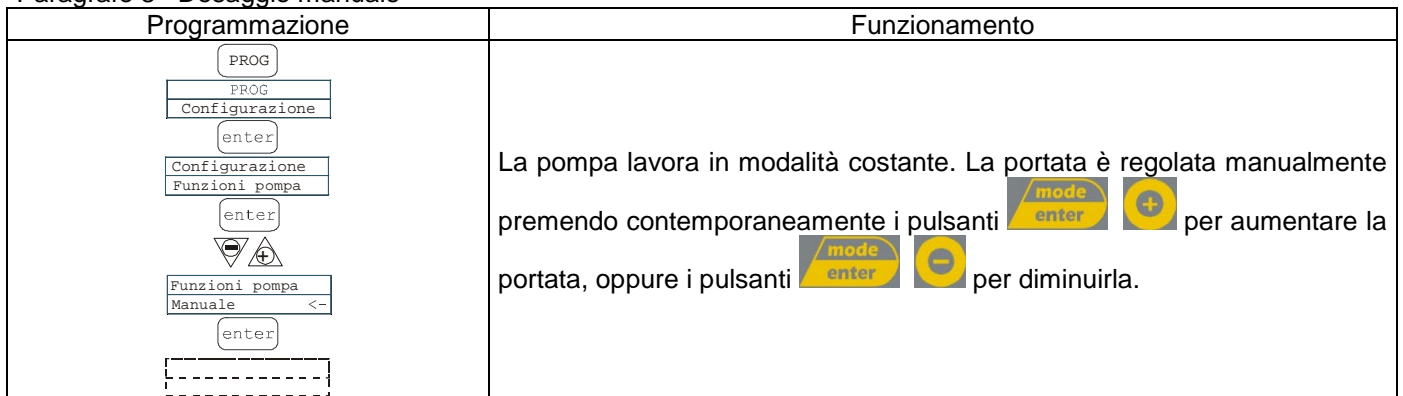

### Paragrafo 4 – Impostazione massima portata

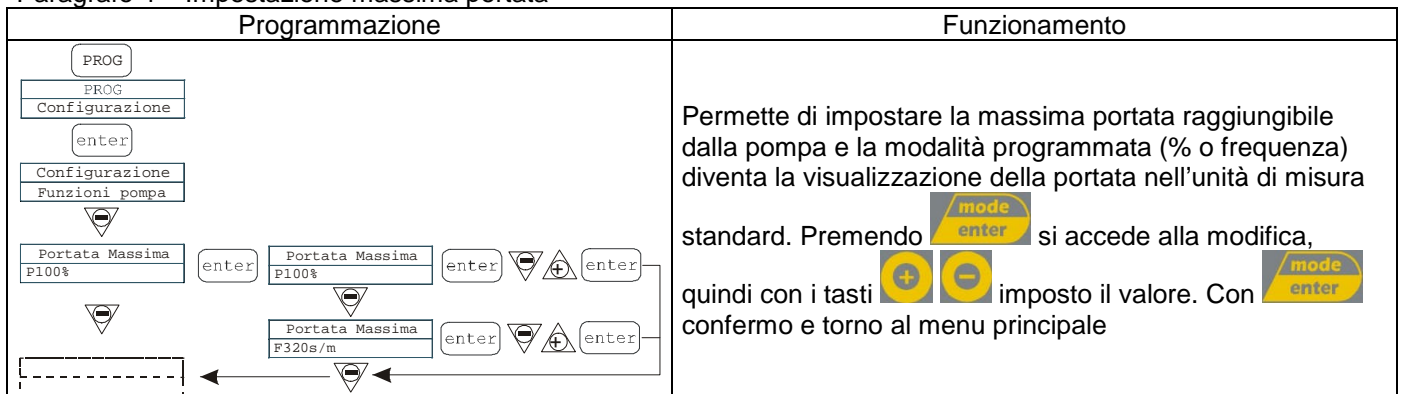

## Paragrafo 5 – Impostazione relé d'allarme

Programmazione	Funzionamento
<pre> graph TD     A[PROG] --&gt; B[PROG Configurazione]     B --&gt; C[Configuration Funzioni Pompa]     C --&gt; D[Portata massima P100%]     D --&gt; E[Relé allarme N.Aperto]     E --&gt; F[ ]     </pre>	<p>Serve ad impostare il relè di allarme in assenza di situazione d'allarme, se aperto (fabbrica) oppure chiuso.</p> <p>Premendo  si accede alla modifica, quindi con i tasti   imposto il valore. Con  confermo e torno al menu principale</p>

## Paragrafo 6 – Impostazione Ritardo Power On

Programmazione	Funzionamento
<pre> graph TD     A[PROG] --&gt; B[PROG Configurazione]     B --&gt; C[Configurazione Funzioni pompa]     C --&gt; D[Portata Massima P100%]     D --&gt; E[Relé Allarme N.Aperto]     E --&gt; F[Lingua Italiano]     F --&gt; G[Ritardo Power ON Off]     G --&gt; H[ ]     </pre>	<p>Permette di impostare un ritardo del funzionamento della pompa all' accensione della stessa. Questo ritardo ha effetto solo se la pompa viene spenta e riaccesa togliendo l'alimentazione.</p> <p>L'impostazione può essere disabilitata, Off (fabbrica) oppure si può impostare un ritardo da 1 a 60 minuti.</p> <p>Con il ritardo attivo, durante il tempo impostato il led allarme e di impulso lampeggiano contemporaneamente (1 sec On – 1 sec Off) e il display mostra il countdown in secondi. Se la pompa è in Stop vengono visualizzati solo i led lampeggianti. Durante il tempo di ritardo può essere disattivata la funzione accedendo al menu, impostando il tempo ad Off.</p> <p>Premendo  si accede alla modifica, quindi con i tasti   imposto il valore. Con  confermo e torno al menu principale</p>

## Paragrafo 7 – Calibrazione portata

Programmazione	Funzionamento
<pre> graph TD     A[PROG] --&gt; B[PROG Configurazione]     B --&gt; C[Calibrazione Pompa 0,23 cc/colpo]     C --&gt; D[Calibrazione Pompa Manuale]     D --&gt; E[Calibrazione Pompa Automatica]     E --&gt; F[Cal. Automatica Start 100 colpi]     F --&gt; G[Cal. Automatica Colpi 100]     G --&gt; H[Cal. Automatica ml 20]     </pre>	<p>Nel menu principale appare il valore di cc a colpo in memoria. È possibile calibrare in due modalità:</p> <p><b>MANUALE</b> – inserisco manualmente il valore di cc a colpo con i tasti   e confermo con </p> <p><b>AUTOMATICA</b> – la pompa esegue 100 colpi, che vengono avviati con il tasto , alla fine dei quali con i tasti   inserisco la quantità aspirata dalla pompa e confermo con .</p> <p>Il dato inserito verrà utilizzato nei calcoli delle portate.</p>

Paragrafo 8 – Statistiche

Programmazione	Funzionamento
<p>The diagram illustrates the menu flow for statistics. It starts with the 'PROG' button leading to the 'Configurazione' menu. From there, it navigates through 'Statistiche' to view 'Ore' (10), 'Colpi' (1000), 'Q.ta(l)' (100), and 'Accensioni' (10). The 'Reset Stat.' option is set to 'NO'. Pressing 'ESC' returns the user to the main menu.</p>	<p>Nel menu principale visualizza le ore di funzionamento della pompa, premendo il tasto  accedo alle altre statistiche:</p> <ul style="list-style-type: none"> <li>- Colpi = numero di colpi eseguito dalla pompa</li> <li>- Q.ta(L) = quantità dosata dalla pompa espressa in litri; questo dato viene calcolato in base al valore cc/colpo in memoria</li> <li>- Accensioni = numero di avviamenti della pompa</li> </ul> <p>- Reset = con i tasti   posso azzerare i contatori (YES) oppure no (NO), con  confermo.</p> <p>La pressione di  permette di tornare al menu principale.</p>

Paragrafo 9 – Password

Programmazione	Funzionamento
<p>The diagram shows the password configuration process. It starts with 'PROG' leading to 'Configurazione'. The user enters a password '****' and then '0000' (factory default). Pressing 'ESC' returns the user to the main menu.</p>	<p>Inserendo la password, potrò entrare in programmazione e vedere tutti i valori impostati, ma ogni volta che cercherò di modificarli verrà richiesta la password.</p> <p>La linea lampeggiante indica il numero modificabile, con il tasto  seleziono il numero (da 1 a 9), con il tasto  seleziono il numero da modificare, quindi con  confermo. Impostando "0000" (fabbrica), la password viene esclusa.</p>

Paragrafo 10 – Allarme di flusso

Programmazione	Funzionamento
<p>The diagram details the flow alarm configuration. It starts with 'PROG' leading to 'Configurazione'. The user sets 'Allarme Flusso' to 'On' and configures 'Allarme Flusso - On Segnali' to '6'. Pressing 'ESC' returns the user to the main menu.</p>	<p>Permette di attivare (disattivare) il sensore di flusso.</p> <p>Una volta attivato (On) premendoli tasto  si accede alla richiesta di quanti segnali aspetta la pompa prima di andare in allarme. Premendo  lampeggia il numero, quindi con i tasti   imposto il valore. Con  confermo. Premendo  torno al menu principale</p>

### Paragrafo 11 – Allarme di livello

Programmazione	Funzionamento
	<p>Permette di impostare la pompa quando si attiva l'allarme del sensore di livello, cioè blocca il dosaggio (Stop), oppure se semplicemente attivare la segnalazione d'allarme senza blocco del dosaggio.</p> <p>Premendo  si accede alla modifica, quindi con i tasti   imposto il tipo di allarme. Con  confermo.</p> <p>Premendo  torno al menu principale</p>

### Paragrafo 12 – Unità visualizzazione portata

Programmazione	Funzionamento
	<p>Permette di impostare l'unità di misura del dosaggio a display in visualizzazione.</p> <p>Premendo  si accede alla modifica, quindi con i tasti   imposto il tipo di unità di misura, L/h (Litri/ora), Gph (Galloni/ora), ml/m (millilitri/minuto) o standard (% o frequenza, a seconda di come impostato). Con  confermo e torno al menu principale</p>

### Paragrafo 13 – Impostazione Pausa

Programmazione	Funzionamento
	<p>Ingresso remoto per mettere in pausa la pompa. In fabbrica il sistema è impostato come Normalmente Aperto.</p> <p>Premendo  si accede alla modifica, quindi con i tasti   imposto il valore (N. APERTO oppure N. CHIUSO)</p> <p>Con  confermo e torno al menu principale.</p>

## Menu Calibrazione pH

Premendo il tasto CAL x 3 secondi si entra nel menu calibrazione, se in programmazione la calibrazione è stata esclusa, sul display appare:

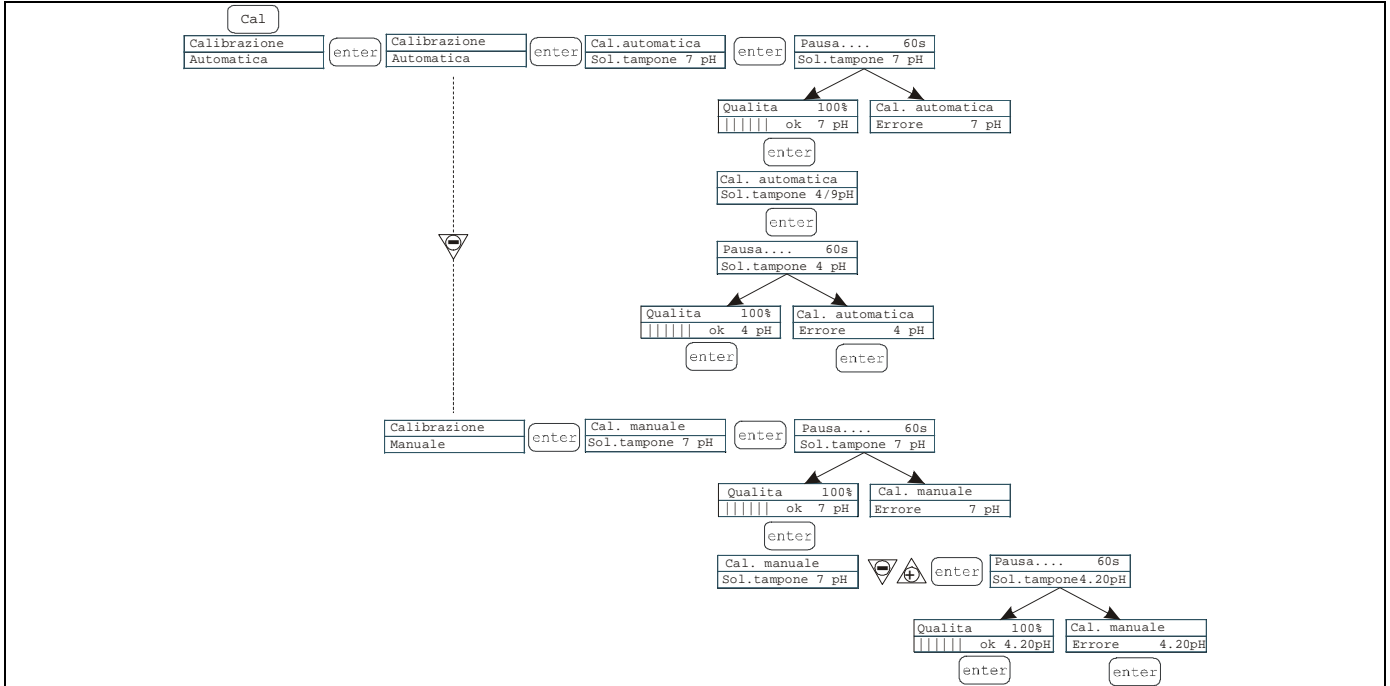

Calibrazione
Off

Se la calibrazione è attiva:





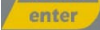



È possibile scegliere la modalità automatica o manuale, in entrambi i casi la calibrazione a pH 7 avviene in automatico.

- Calibrazione automatica:

Sul display appare il valore della soluzione tampone, inserire la sonda nella boccetta, premendo  a display appare il conteggio alla rovescia dei 60 secondi necessari a completare la calibrazione. Se la qualità dell'allineamento è inferiore al 50% appare errore a display e premendo  si esce dalla calibrazione (dopo 4 secondi la pompa esce automaticamente), se la qualità è superiore al 50%, il valore viene visualizzato a display e premendo  viene richiesta la soluzione tampone a pH 4 o 9; a questo punto la procedura è uguale alla precedente.

- Calibrazione manuale:

quando sul display appare il valore della soluzione tampone inserire la sonda nella boccetta, premendo  a display appare il conteggio alla rovescia dei 60 secondi necessari a completare la calibrazione. Se la qualità dell'allineamento è inferiore al 50% appare errore a display e premendo  si esce dalla calibrazione (dopo 4 secondi la pompa esce automaticamente), se la qualità è superiore al 50%, il valore viene visualizzato a display e premendo  sul display lampeggia il valore di pH 7.00, con i tasti   inserisco il valore della soluzione in mio possesso, quindi premendo  confermo ed avvio la procedura di calibrazione come in precedenza.

## Menu Calibrazione Potenziale Redox (O.R.P.)

Premendo il tasto CAL x 3 secondi si entra nel menu calibrazione, se in programmazione la calibrazione è stata esclusa, sul display appare:

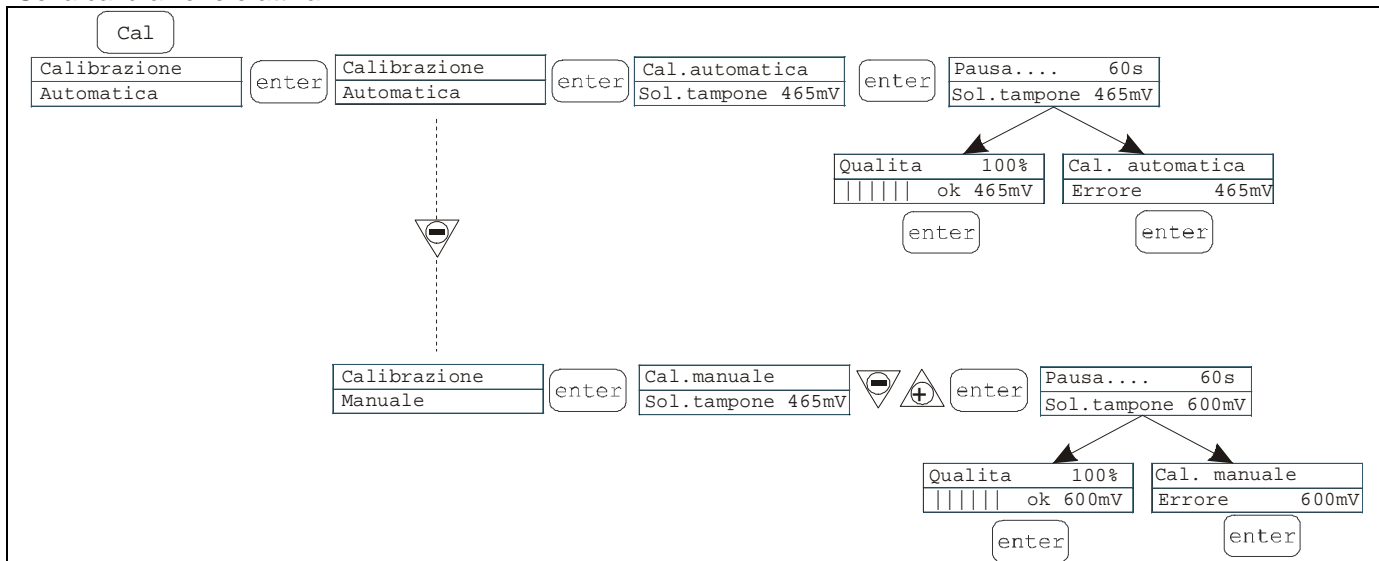

Calibrazione
Off

Se la calibrazione è attiva:







È possibile scegliere la modalità automatica o manuale.



- Calibrazione automatica:

sul display appare il valore della soluzione tampone inserire la sonda nella boccetta, premendo  a display appare il conteggio alla rovescia dei 60 secondi necessari a completare la calibrazione. Se la qualità dell'allineamento è inferiore al 50% appare errore a display e premendo  si esce dalla calibrazione (dopo 4 secondi la pompa esce automaticamente), se la qualità è superiore al 50%, il valore viene visualizzato a display e premendo  viene completata la procedura.

- Calibrazione manuale:

sul display appare il valore della soluzione tampone inserire la sonda nella boccetta, premendo  sul display lampeggia il valore di 465mV, inserisco la sonda nella mia soluzione, quindi con i tasti   visualizzo il valore della soluzione in mio possesso, quindi premendo  confermo ed avvio la procedura di calibrazione come in precedenza.

## Allarmi

Visualizzazione	Causa	Interruzione				
Led Alarm fisso Scritta Lev lampeggiante Es: <table border="1" style="display: inline-table; vertical-align: middle;"> <tr> <td>Man</td> <td></td> </tr> <tr> <td>Lev</td> <td>P100%</td> </tr> </table>	Man		Lev	P100%	Allarme fine di livello, senza interruzione del funzionamento della pompa.	Ripristino del livello del liquido.
Man						
Lev	P100%					
Led Alarm fisso Scritta Lev e Stop lampeggianti Es: <table border="1" style="display: inline-table; vertical-align: middle;"> <tr> <td>Man</td> <td></td> </tr> <tr> <td>Lev Stop</td> <td>P100%</td> </tr> </table>	Man		Lev Stop	P100%	Allarme fine di livello, con interruzione del funzionamento della pompa.	Ripristino del livello del liquido.
Man						
Lev Stop	P100%					
Led Alarm fisso Scritta Flw lampeggiante Es: <table border="1" style="display: inline-table; vertical-align: middle;"> <tr> <td>Man</td> <td><b>E</b></td> </tr> <tr> <td>Flw</td> <td>P100%</td> </tr> </table>	Man	<b>E</b>	Flw	P100%	Allarme di flusso attivo, la pompa non ha ricevuto il numero di segnali programmati dal sensore di flusso.	Pressione del tasto 
Man	<b>E</b>					
Flw	P100%					
Es: <table border="1" style="display: inline-table; vertical-align: middle;"> <tr> <td>Parameter Error</td> <td></td> </tr> <tr> <td>PROG to default</td> <td></td> </tr> </table>	Parameter Error		PROG to default		Errore di comunicazione con la eeprom.	Pressione del tasto  per ripristinare i parametri di fabbrica.
Parameter Error						
PROG to default						
Scritta "OFA" lampeggiante Scritta "Stop" lampeggiante Es: <table border="1" style="display: inline-table; vertical-align: middle;"> <tr> <td>High</td> <td>475 mV OFA</td> </tr> <tr> <td>Stop</td> <td>P 75%</td> </tr> </table>	High	475 mV OFA	Stop	P 75%	Allarme O.F.A.	Pressione del tasto  per bloccare il lampeggio della scritta Stop, ulteriore pressione del tasto per riavviare la pompa.
High	475 mV OFA					
Stop	P 75%					
Scritta "Alm" lampeggiante Es: <table border="1" style="display: inline-table; vertical-align: middle;"> <tr> <td>High</td> <td>475 mV Alm</td> </tr> <tr> <td>P</td> <td>75%</td> </tr> </table>	High	475 mV Alm	P	75%	Il valore letto dalla sonda è fuori dall'intervallo della banda d'allarme impostata	Controllare la corretta impostazione del parametro "Banda Allarme" in programmazione.
High	475 mV Alm					
P	75%					
Scritta "Cal" lampeggiante Es: <table border="1" style="display: inline-table; vertical-align: middle;"> <tr> <td>High</td> <td>475 mV Cal</td> </tr> <tr> <td>P</td> <td>75%</td> </tr> </table>	High	475 mV Cal	P	75%	Allarme sonda non calibrata	Effettuare la procedura di calibrazione della sonda.
High	475 mV Cal					
P	75%					